

MEGA 360 IMAGING

Operations Guide

532731-1EN_A



 **HUMMINBIRD®**

SIMPLY. CLEARLY. BETTER.

THANK YOU!

Thank you for choosing Humminbird®, the #1 name in marine electronics. Humminbird has built its reputation by designing and manufacturing top quality, thoroughly reliable marine equipment. Your Humminbird is designed for trouble-free use in even the harshest marine environment. In the unlikely event that your Humminbird does require repairs, we offer an exclusive Service Policy. For complete details, see the separate warranty card included with your unit. We encourage you to read this operations manual carefully in order to get the full benefit from all the features and applications of your Humminbird product.

Contact Humminbird Technical Support at humminbird.com or call **1-800-633-1468**.

 **WARNING!** This device should not be used as a navigational aid to prevent collision, grounding, boat damage, or personal injury. When the boat is moving, water depth may change too quickly to allow time for you to react. Always operate the boat at very slow speeds if you suspect shallow water or submerged objects.

 **WARNING!** The electronic chart in your Humminbird unit is an aid to navigation designed to facilitate the use of authorized government charts, not to replace them. Only official government charts and notices to mariners contain all of the current information needed for the safety of navigation, and the captain is responsible for their prudent use.

 **WARNING!** Humminbird is not responsible for the loss of data files [waypoints, routes, tracks, groups, recordings, etc.] that may occur due to direct or indirect damage to the unit's hardware or software. It is important to back up your control head's data files periodically. Data files should also be saved to your computer before restoring the control head defaults or updating the software. Visit our Web site at humminbird.com and download your control head operations manual for details.

 **WARNING!** Disassembly and repair of this electronic unit should only be performed by authorized service personnel. Any modification of the serial number or attempt to repair the original equipment or accessories by unauthorized individuals will void the warranty.

 **NOTE:** Some features discussed in this manual require a separate purchase, and some features are only available on international models. Every effort has been made to clearly identify those features. Please read the manual carefully in order to understand the full capabilities of your model.

 **NOTE:** The illustrations in this manual may not look the same as your product, but your unit will function in a similar way.

 **NOTE:** To purchase accessories for your control head, visit our Web site at humminbird.com or contact Humminbird Technical Support at **1-800-633-1468**.

 **NOTE:** The procedures and features described in this manual are subject to change without notice. This manual was written in English and may have been translated to another language. Humminbird is not responsible for incorrect translations or discrepancies between documents.

 **NOTE:** Product specifications and features are subject to change without notice.

 **NOTE:** Humminbird verifies maximum stated depth in saltwater conditions, however actual depth performance may vary due to transducer installation, water type, thermal layers, bottom composition, and slope.

 **NOTE:** For MEGA 360 Imaging troubleshooting and maintenance information, please see your **MEGA 360 Imaging Installation Guide**. The guide can also be downloaded from our Web site at humminbird.com.

ATTENTION INTERNATIONAL CUSTOMERS: Products sold in the U.S. are not intended for use in the international market. Humminbird international units provide international features and are designed to meet country and regional regulations. Languages, maps, time zones, units of measurement, and warranty are examples of features that are customized for Humminbird international units purchased through our authorized international distributors.

To obtain a list of authorized international distributors, please visit our Web site at humminbird.com or contact Humminbird Technical Support at **(334) 687-6613**.

ENVIRONMENTAL COMPLIANCE STATEMENT: It is the intention of Johnson Outdoors Marine Electronics, Inc. to be a responsible corporate citizen, operating in compliance with known and applicable environmental regulations, and a good neighbor in the communities where we make or sell our products.

WEEE DIRECTIVE: EU Directive 2002/96/EC "Waste of Electrical and Electronic Equipment Directive [WEEE]" impacts most distributors, sellers, and manufacturers of consumer electronics in the European Union. The WEEE Directive requires the producer of consumer electronics to take responsibility for the management of waste from their products to achieve environmentally responsible disposal during the product life cycle.

WEEE compliance may not be required in your location for electrical & electronic equipment (EEE), nor may it be required for EEE designed and intended as fixed or temporary installation in transportation vehicles such as automobiles, aircraft, and boats. In some European Union member states, these vehicles are considered outside of the scope of the Directive, and EEE for those applications can be considered excluded from the WEEE Directive requirement.



This symbol (WEEE wheelie bin) on product indicates the product must not be disposed of with other household refuse. It must be disposed of and collected for recycling and recovery of waste EEE. Johnson Outdoors Marine Electronics, Inc. will mark all EEE products in accordance with the WEEE Directive. It is our goal to comply in the collection, treatment, recovery, and environmentally sound disposal of those products; however, these requirements do vary within European Union member states. For more information about where you should dispose of your waste equipment for recycling and recovery and/or your European Union member state requirements, please contact your dealer or distributor from which your product was purchased.

ROHS STATEMENT: Product designed and intended as a fixed installation or part of a system in a vessel may be considered beyond the scope of Directive 2002/95/EC of the European Parliament and of the Council of 27 January 2003 on the restriction of the use of certain hazardous substances in electrical and electronic equipment.

360 Imaging®, Cross Touch®, Down Imaging®, Fortrex™, HELIX®, Humminbird®, Maxxum®, MEGA 360 Imaging™, Minn Kota®, Side Imaging®, SOLIX®, Ultrex™, and X-Press™ Menu are trademarked by or registered trademarks of Johnson Outdoors Marine Electronics, Inc.

Adobe, Acrobat, Adobe PDF, and Reader are either registered trademarks or trademarks of Adobe Systems Incorporated in the United States and/or other countries.

TABLE OF CONTENTS

Introduction	5	Zoom In/Out	37
Important Information	5	Activate the Cursor	37
Humminbird Control Head.....	5	Zoom In/Out	37
MEGA 360 Imaging Sonar	6	Change the Sweep Speed and Range	38
Power On and Confirm Connections	8	Change the Sweep Speed	38
1. Power On the MEGA 360 Imaging Transducer and the Control Head.....	8	Change the 360 Range.....	38
2. Confirm MEGA 360 Connection on the Humminbird Control Head	8	Isolate a Section of the Sweep	40
3. Confirm GPS Reception	10	Activate Quick Sweep	40
Update Software	13	Isolate the Sweep Area	40
Register Products	13	Select a Preset Display.....	41
Export Settings and Navigation Data	13	Change the Frequency	42
Check the Current Software Version	14	Mark and Display Waypoints	43
Update Control Head Software with an SD Card	15	Turn On/Off Navigation in the MEGA 360 Views [HELIX only].....	43
Update Accessory Software with an SD Card	15	Mark a Waypoint	43
Update Software with FishSmart	16	Power Off	45
Set Up MEGA 360 on the Network	17	Contact Humminbird	46
SOLIX Series Networking.....	17		
HELIX Series Networking.....	18		
Start/Stop MEGA 360 Imaging Operation	21		
Start Pinging	21		
Stop Pinging	23		
Wet Switch	24		
What's on the MEGA 360 Imaging Display	25		
MEGA 360 Imaging Views	26		
SOLIX Series Views.....	26		
HELIX Series Views	27		
360 View	27		
360/Sonar Combo View.....	28		
360/Chart Combo View.....	29		
Side Imaging View.....	30		
Change the 360 View Display Settings	31		
Change the Display Settings.....	31		
Change the View Color.....	34		
Customize the View	35		
Customize the 360 View on SOLIX Series.....	35		
Adjust 360 Enhance Settings on HELIX Series	36		

Introduction

Thank you for purchasing the Humminbird® MEGA 360 Imaging™ transducer. MEGA 360 Imaging brings the unmatched coverage of 360 Imaging technology into the megahertz range for next-level detail. We encourage you to read this manual carefully in order to understand MEGA 360 Imaging and how to use this Humminbird advanced accessory on the water. Some of the equipment requirements and menu options depend on your control head. Whether you have a SOLIX® or HELIX® fish finder, every effort has been made to clearly identify those features throughout this manual.

Important Information

Before you use the MEGA 360 Imaging transducer on the water, it is important to understand the following:

Speed	The MEGA 360 Imaging transducer pod can be used in the water at 0 to 7 mph. The transducer pod should NOT be in the water during high speed travel.
Obstructions	Be aware of obstructions in the water that could damage the transducer pod.
Powering Off	When the boat is at dock or in storage, the MEGA 360 Imaging transducer should be turned off at the switch to prevent wear and tear. See Power Off for more information.
Setting Up the Control Head	The control head must be set up correctly to add the MEGA 360 Imaging features to the Menu System and View Rotation. See Set Up MEGA 360 on the Network and MEGA 360 Imaging Views .

Humminbird Control Head

This accessory manual describes the functionality that is added to your SOLIX or HELIX control head when it is connected to the MEGA 360 Imaging transducer. For additional information about the Humminbird control head operations, see your control head operations manual. To download the manual from our Web site, go to humminbird.com.

Compatibility

MEGA 360 Imaging is compatible with all SOLIX models and HELIX G3N models with MEGA+ Imaging. MEGA 360 Imaging can be shared over Ethernet with all SOLIX models and HELIX G2N and G3N units.

MEGA 360 Imaging Sonar

The MEGA 360 Imaging transducer pod deploys into the water with the your Minn Kota® Ultrex™, Fortrex®, or Maxxum® trolling motor. It is independently mounted, so your sonar picture remains unchanged as the trolling motor turns. See the **MEGA 360 Imaging Installation Guide** for more information.

The beams sweep to provide an unobstructed, 360° view of the area around and below your boat. As it sweeps, the MEGA 360 Imaging transducer scans the water with its razor-thin, high-definition beams. Visualize the MEGA 360 Imaging beams as a thin sonar wall extending 125 feet in every direction around your boat. This wall rotates to create a 250-foot circle. The beams are wide from side to side but very thin from front to back.

The MEGA 360 Imaging rotating beams can also be set to provide Side Imaging® views on the screen. See **Set Up MEGA 360 on the Network** and **MEGA 360 Imaging Views** for more information.

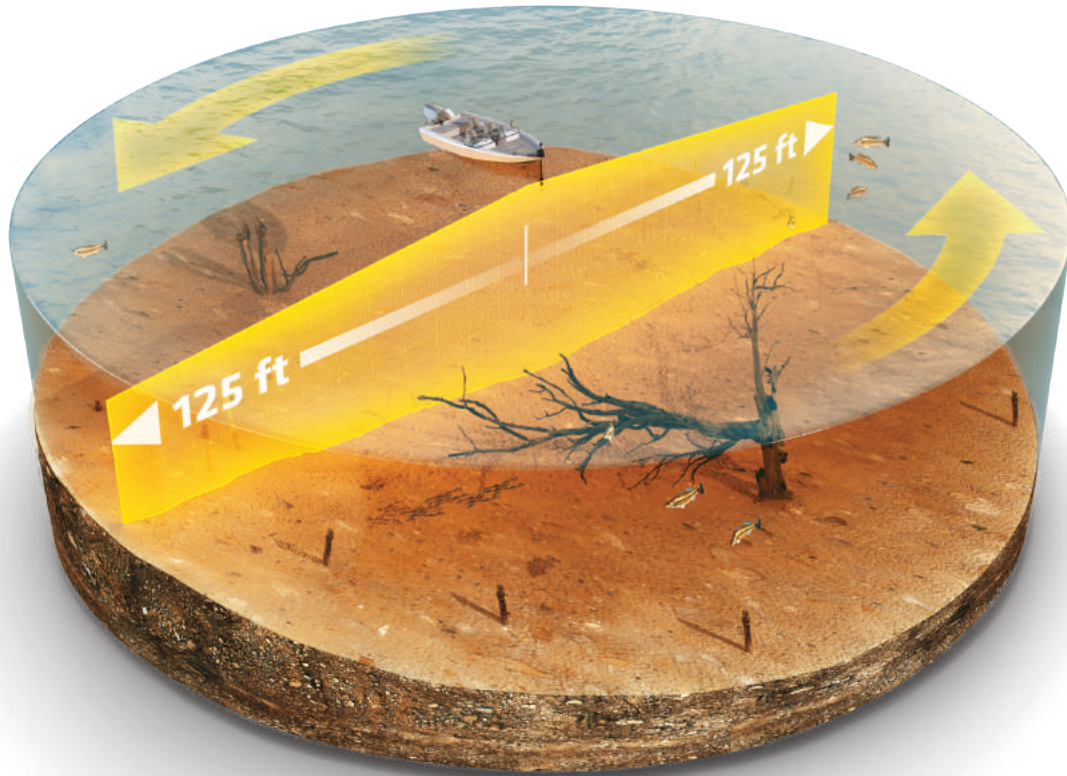

 **NOTE:** The transducer's performance is affected by such factors as boat speed, wave action, bottom hardness, water conditions, and installation.

The sweep line on the MEGA 360 Imaging display reveals detailed sonar returns in real time. The historical returns remain on the display until the beams sweep again. You can use the light and dark parts of the display to interpret the objects under your boat as follows:

- Dark shades represent soft returns (mud, sand) or descending terrain.
- Light shades represent denser terrain (timber, rocks) or rising terrain. A very hard bottom may appear as white on the display.
- White streaks or clouds may represent fish on the display.
- Shadows: An object that is standing on the bottom will appear as a clearly defined bright shape with an adjacent dark sonar “shadow.” The longer the shadow, the taller the object. Fish may also cast shadows. You can use the shadow to interpret where the fish or object is located in relation to the bottom.

MEGA 360 View (SOLIX)

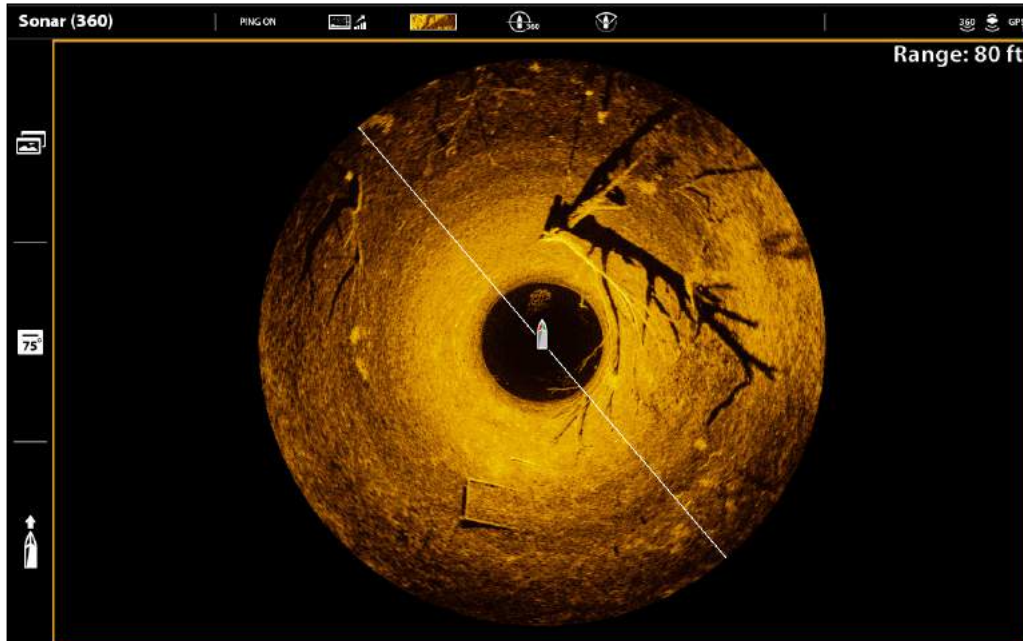

Power On and Confirm Connections

All equipment should be connected and powered before you turn on the control head. See the *MEGA 360 Imaging Installation Guide* for more information.

When the control head detects the MEGA 360 Imaging transducer, it will select it automatically as the 360 sonar source. The related views and menus will be added to the system. Use the following instructions to power on the control head and confirm the MEGA 360 Imaging transducer and the GPS receiver/compass (heading sensor) are detected by the unit.

CAUTION! It is important to finish all installation connections before powering on the control head.

NOTE: You must have a GPS receiver/compass (heading sensor) installed in order to use the MEGA 360 Imaging navigation features.

1 | Power On the MEGA 360 Imaging Transducer and the Control Head

SOLIX Series

1. Turn on the power source from the main switch.
2. On the control head, press and hold the POWER key.

If you are powering on a control head in a multiple-control head Ethernet network, power on the control head that is connected to the MEGA 360 Imaging transducer first.

3. Select Normal mode.

HELIX Series

1. Turn on the power source from the main switch.
2. On the control head, press the POWER key.

If you are powering on a control head in a multiple-control head Ethernet network, power on the control head that is connected to the MEGA 360 Imaging transducer first.

3. When the Title screen is displayed, press the MENU key to open the Start-Up Options Menu.
4. Use the Cursor Control key to choose Normal, and press the RIGHT Cursor key to select it.

2 | Confirm MEGA 360 Connection on the Humminbird Control Head

SOLIX Series

You can confirm the MEGA 360 connection by checking the system status bar. Each accessory connected to the Humminbird control head is represented by a status icon in the system status bar.





SOLIX Status Bar [top of screen]



1. Press the HOME key.
2. Review the top, right corner of the status bar.

Confirm MEGA 360 is shown as Connected and In Water. It may take up to one minute for the MEGA 360 to be detected.

Unconnected: If the MEGA 360 icon is not shown in the status bar, check the cable and power connections to confirm they are secure and powered on. Review the installation guide that was included with your MEGA 360 Imaging transducer to confirm it is installed correctly.

MEGA 360 Status Icon	Icon Description
	Connected/In Water/Pinging: The MEGA 360 is connected, in the water, and pinging.
	Connected/In Water/Not Pinging: The MEGA 360 is connected and in the water, but it is not pinging.
	Connected/Out of Water: The MEGA 360 is connected, but the wet indicator is out of the water.
	Connection Lost: The connection to the MEGA 360 was lost.

 **NOTE:** For additional system status, select Home > Settings > Network > System Info.

HELIX Series

You can confirm the MEGA 360 connection by checking the Accessory Test view.

1. Press and hold the VIEW key.
2. Select System > Accessory Test.

Confirm MEGA 360 is shown as Connected. It may take up to one minute for the MEGA 360 to be detected.

Unconnected: If the MEGA 360 icon is listed as Unconnected, check the cable and power connections to confirm they are secure and powered on. Review the installation guide that was included with your MEGA 360 Imaging Transducer to confirm it is installed correctly.

HELIX Accessory Test

Accessory Test	
360 Imaging	UNCONNECTED
BT Talon	UNCONNECTED
GPS	CONNECTED
i-Pilot	UNCONNECTED
MEGA 360 Imaging v1.040 S/N: 19082901-0072	CONNECTED
NMEA2K Gateway	UNCONNECTED
Radar	UNCONNECTED
Remote	UNCONNECTED
Speed	UNCONNECTED
Temperature	CONNECTED

GPS + Heading Sensor listed as connected

MEGA 360 Imaging listed as connected

Temp.1 |°F
72.2

N 34°06.248'
W 084°12.385'

Time
7:01

Speed |mph
0.2



VLT |V
13.4

3 | Confirm GPS Reception



Use the instructions in this section to confirm the control head has GPS reception. GPS and a compass (heading sensor) are required to enable the navigation features on the control head with the MEGA 360 Imaging transducer.

SOLIX Series

1. From the Home screen, review the top, right corner of the status bar, and confirm the GPS receiver is detected and active.

GPS Status Icon	Icon Description
	Detected and Active: The GPS receiver is detected and a GPS fix has been obtained.
	Connected but not Transmitting/Receiving: The GPS receiver is detected, but it doesn't have a GPS fix.
	Connected but not Detected or Active: The GPS receiver is connected, but not detected on the network or no GPS fix has been obtained.

2. If the Detected and Active icon is visible, GPS fix has been obtained.
3. From the HOME screen, review the top, right corner of the status bar, and confirm the compass (heading sensor) is on and data is being received.

Compass Status Icon	Icon Description
	Detected and Active: The compass (heading sensor) is on and heading data is being received.
	Connected but not Detected or Active: The compass is not detected on the network and not transmitting data.

Check GPS Reception and Satellite Strength

The GPS tool provides two ways to view the satellites communicating with the GPS receiver. **Yellow** indicates that the satellite is being used to determine your current position. **Teal** indicates that the satellite is being monitored but not used. The following data is also displayed:

- **Position** [latitude and longitude]
- **GPS Fix Type:** reported as No Fix, 2D Fix, 3D Fix, or Enhanced. An Enhanced fix has been augmented using information from WAAS, EGNOS, or MSAS. A 3D or Enhanced Fix is required for navigation.
- **HDOP (the Horizontal Dilution of Precision):** a GPS system parameter which depends on the current satellite configuration. HDOP is used to calculate the Estimated Position Error.

1. Press the HOME key.
2. Select the **GPS** tool.
3. Depending on your network configuration, select **GPS [1] > Satellites** or **GPS [2] > Satellites**.

 **NOTE:** You can manually change which GPS receiver is the selected source for GPS [1] or GPS [2]. For more information about GPS and selecting GPS sources, see your control head operations manual.

GPS [1] Satellite Sky Chart

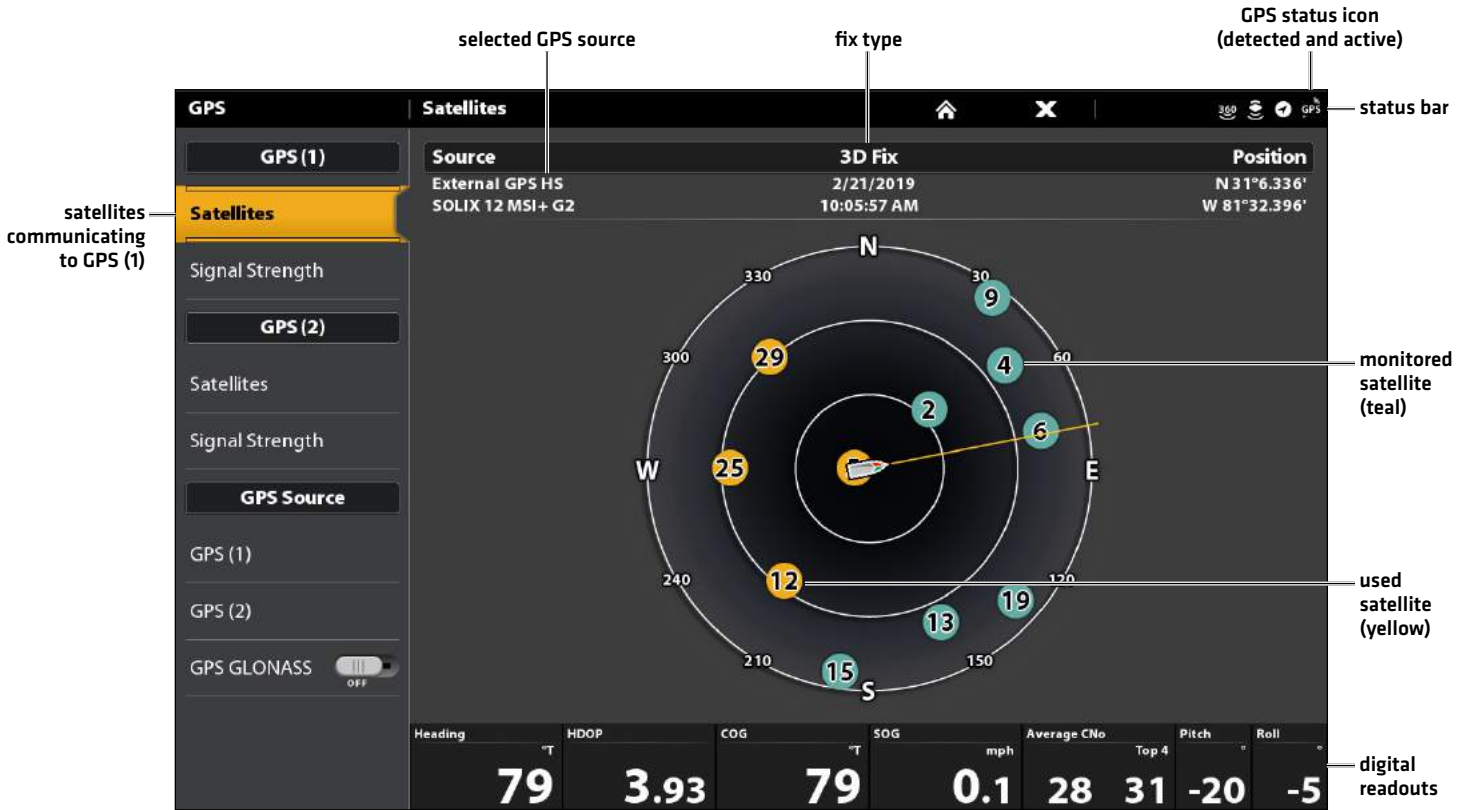

4. Under GPS [1] or GPS [2], select Signal Strength.

Signal Strength (bar graph)



Signal Strength (GPS 1/GPS 2): displays vertical bar graphs indicating the satellite signal strengths with the respecting CNO (Carrier-to-Noise) value (0 to 60).

HELIX Series

1. Press and hold the VIEW key.
2. Select System > Accessory Test.

Confirm that GPS + Heading Sensor (optional) are listed as Connected. See the illustration *HELIX Accessory Test*.

3. Press and hold the VIEW key.
4. Select System > GPS Diagnostic View.

Confirm **GPS Fix Type** is shown as Enhanced or 3D.

Confirm that the **latitude/longitude position** readout is displayed.

 **NOTE:** If the GPS Diagnostic View or Accessory Test is not displayed in the View Rotation, press the MENU key twice to open the Main Menu. Select the Views tab > GPS Diagnostic View or Accessory Test. Change the setting for each view to Visible.

Reviewing GPS Reception (HELIX)

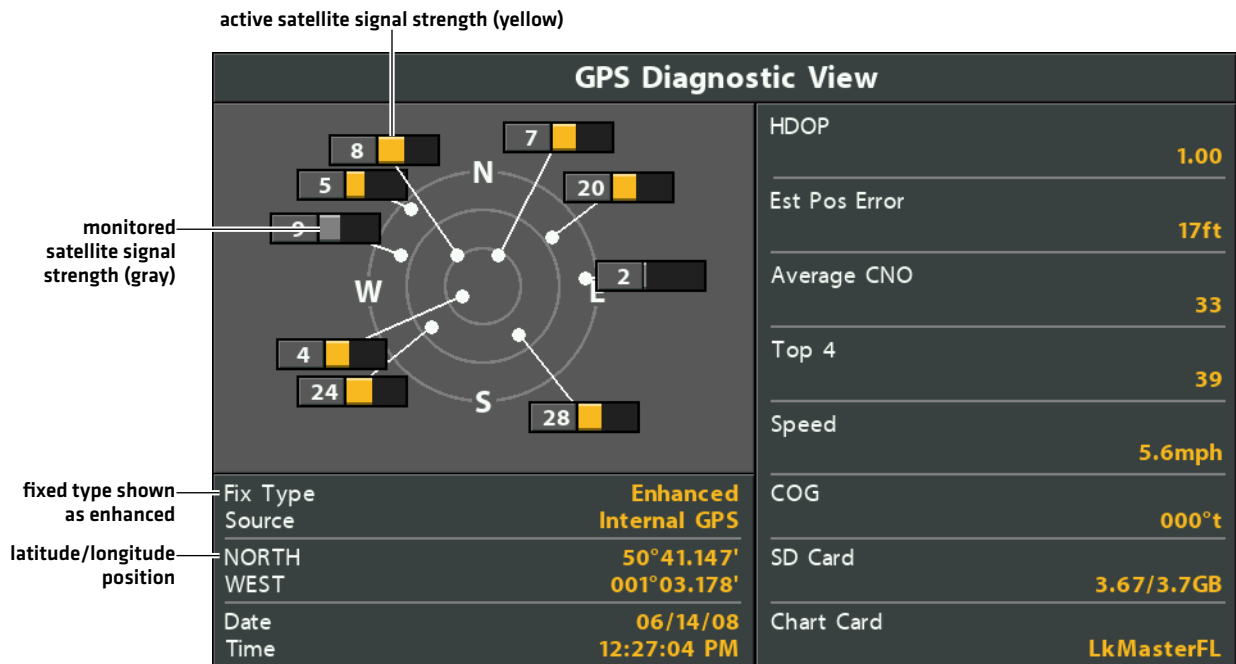

GPS Reception: The sky chart displays the satellite number and signal strength bar.

GPS Fix Type: reported as No Fix, 2D Fix, 3D Fix, or Enhanced. An Enhanced Fix has been augmented using information from WAAS, EGNOS, or MSAS.

HDOP [the Horizontal Dilution of Precision]: a GPS system parameter which depends on the current satellite configuration. HDOP is used to calculate the Estimated Position Error.

 **NOTE:** To manually change your GPS source, change the output frequency, or turn on GLONASS, see Manage your Control Head.

Update Software

Your control head model may need a software update to work with the MEGA 360 Imaging transducer. We recommend that you read the following section completely before starting any software updates.

Control Head Required Software: The following control head software version is required to operate the MEGA 360 Imaging transducer:

- SOLIX G2 Series: 3.520 or higher
- HELIX G3N Series: 2.130 or higher

MEGA 360 Software: The MEGA 360 has separate software updates from the control head. After the software is updated on the control head, you must download any accessory software updates. See your control head operations manual for more details.

Preparation: We recommend that you read the following section completely before starting any software updates. The Humminbird control head will take approximately 10 minutes to update, and each Humminbird control head on the network must be updated individually. Accessories take approximately 3 minutes to update.

Supplies: In addition to your Humminbird equipment, you will need a computer with Internet access and a blank SD or microSD card (depending on your control head).

Technical Support: If you have any questions about the software update process, contact Technical Support by visiting our Web site at humminbird.com or by calling **1-800-633-1468**.

Register Products

Register your Humminbird equipment so that you will receive the latest Humminbird news, including accessory compatibility and software update information.

1. Go to our Web site at humminbird.com. Select Support > Register Your Product.
2. Follow the on-screen prompts to register your products.

Export Settings and Navigation Data

Before the control head software is updated or restored to system defaults, it is important to back up your control head data files (including navigation data and screen snapshots) and menu settings to an SD or microSD card.

WARNING! Humminbird is not responsible for the loss of data files (waypoints, routes, tracks, groups, snapshots, recordings, etc.) that may occur due to direct or indirect damage to the unit's hardware or software. It is important to back up your control head's data files periodically. Data files should also be saved to your computer before restoring the unit's defaults or updating the software.

WARNING! Do NOT leave the control head SD or microSD card slot cover open. The slot cover should always be closed to prevent water damage to the unit.

NOTE: See your control head operations manual for more information about exporting settings and navigation data.

SOLIX Series

Export Data and Menu Settings

Use the instructions in this section before you restore the control head defaults or update software.

1. Install the SD or microSD card into the control head card slot.
2. Press the HOME key.
3. Select the Files tool.

Inserting an SD Card

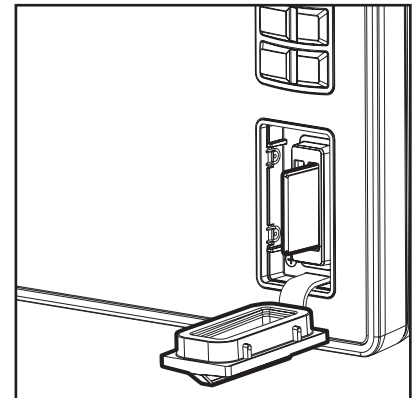

Vertical Slot:
Insert the SD card with the label facing left.

Horizontal Slot:
Insert the SD card with the label facing up.

4. Under Export, select Nav Data.
5. Follow the on-screen prompts.
6. **Select a Save Location:** Save to the SD Card.
7. Repeat steps 4 and 5 to export Menu Settings and Radar Installation settings [if applicable to your installation].
8. **Networked Units:** Repeat the steps in this section on each control head.

Copy Internal Images

If you have screen snapshots saved to the control head, use the following instructions to copy them to an SD or microSD card.

1. Confirm the SD or microSD card is installed in the control head card slot.
2. Press the HOME key.
3. Select the Images tool. Tap the icon, or press the ENTER key, to open.
4. Under Source, select Internal.
5. Press and hold one of the screen snapshots.

OR

Use the Joystick to select a screen snapshot. Press the MENU key.

6. Select Copy All.
7. **Select a Save Location:** Save to the SD Card [left slot = SD Card 1, right slot = SD Card 2]
8. Repeat the steps in this section on each control head.

HELIX Series

Export Navigation Data

1. Install the SD card or microSD card according to the instructions in your control head operations manual.
2. Power on the control head.
3. **Main Menu:** Press the MENU key twice. Select the Nav tab.
4. Select Waypoints, Routes, Tracks. Press the RIGHT Cursor key.
5. Select Options > Select All and ... > Export.
6. Follow the on-screen prompts to confirm or cancel the export.

Check the Current Software Version

It is helpful to review the software version number that is currently installed on the control head and each accessory.

SOLIX Series

1. Press the HOME key.
2. Select Settings > Network > Network Info.
3. The Network Info dialog box shows a section for each device connected to the network. Scroll to each section to note the software version number listed.

HELIX Series

1. Press and hold the VIEW key.
2. Select System > System Status.
3. Confirm the Software Version listed.

Update Control Head Software with an SD Card

 **WARNING!** Before the control head software is updated or restored to system defaults, export your menu settings, radar settings, and navigation data. Copy your screen snapshots to an SD card. See **Export Settings and Navigation Data** for details.

 **NOTE:** If you have more than one control head on the network, go to each control head to install the latest software update. Control head software updates cannot be updated through another networked unit.

 **NOTE:** When you install the SD card with the software file into your control head, the control head will detect the update and provide an automatic prompt to install the software. You can follow the prompts or choose to install the software at a later time. See your control head operations manual for more information.

1. Install a formatted SD or microSD card into the computer card slot.
2. Go to **humminbird.com**, and click Support > Software Updates.
3. Click on your control head model. The available software updates are listed as downloads under each product. Confirm the file name is for your control head model.
 - Read the notices and instructions, and select Download.
 - Follow the on-screen prompts to save the software file to the SD or microSD card.
4. Repeat step 3 to download the software updates posted to each product.
5. Insert the SD or microSD card (with the software file) into the control head card slot.
6. Power on your Humminbird control head. Start **Normal** mode.
7. Follow the on-screen prompts to update the control head software.
8. When the software update is complete, remove the SD or microSD card from the control head card slot.
9. **Restart:** If you don't have any other software updates to install, power off the control head, and restart it.

Update Accessory Software with an SD Card

1. Install a formatted SD or microSD card into the computer card slot.
2. Go to **humminbird.com**, and click Support > Software Updates.
3. Scroll down to Accessories and Mapping. The available software updates are listed as downloads under each accessory product. Confirm your control head model is listed in the software description.
 - Read the notices and instructions, and select Download.
 - Follow the on-screen prompts to save the software file to the SD or microSD card.
4. Insert the SD or microSD card (with the software file) into the control head card slot.
5. Power on your Humminbird control head. Start **Normal** mode.
6. **SOLIX:** Select the Files tool. From the Software Update tab, scroll to MEGA 360 on the Accessories list. Confirm that the most current software version is selected from the list, and select Install Now.
HELIX: The software will be automatically detected. It may take up to two minutes for the software to be detected on the network, and the control head will display a dialog box to indicate that the update is in progress.
7. When the software update is complete, remove the SD or microSD card from the control head card slot.
8. **Restart:** If you don't have any other software updates to install, power off the control head, and restart it.

Update Software with FishSmart

You can use the FishSmart App to download and push software updates directly to your Humminbird control head or accessory.



NOTE: Your control head must already be running software release 1.610 or higher for HELIX Series or 3.110 or higher for SOLIX Series to support this feature.



NOTE: You must first download the FishSmart App and pair your mobile device to your control head. See the FishSmart User Manual for more information.

1. Open the FishSmart App on your mobile device.
2. **Apple iOS:** Tap the System menu icon.
Google Android: Tap the FishSmart main menu. Select system.
3. Tap Update next to the selected unit. The download progress is displayed on the screen.
4. Tap Transfer next to the selected unit once the download is complete.
5. Confirm the estimated transfer time.
6. Tap the checkbox to select where to upload the software update [internal storage, card slot 1, or card slot 2].



NOTE: For SOLIX Series control heads, you cannot download software updates to an SD or microSD card with LakeMaster charts saved to it.

7. Tap Transfer. The upload progress is displayed on the System menu in FishSmart and in the System Status view on the control head.
8. Follow the on-screen prompts on the control head to complete the software installation.

Set Up MEGA 360 on the Network

Use the instructions in this section if you have more than one Humminbird control head connected to the network. Configuring the network synchronizes the control head settings.



NOTE: If you have selected the MEGA 360 Imaging transducer on the network during the installation, the other settings in this section are optional. The depth source, temperature source, and alarms will be selected automatically based on the other connected equipment. Use this section to confirm installation settings or to change the sources to your preference. The settings will be saved after you power off the control head.

Before you start, make sure all of your control heads and sources [GPS, transducers, temp/speed accessories, etc.] for your fishing system have been installed. See the equipment installation guides for details. You may need to purchase an Ethernet switch, Ethernet connection cables, or y-cables, depending on your setup.

When the Humminbird network is installed, each control head automatically selects a primary source [transducer, temperature, and GPS]. The control head selects the equipment connected to it as its primary source, but you can choose any compatible source on the network. Make sure to review the **MEGA 360 Installation Guide** to ensure MEGA 360 Imaging is set up as the sonar source.



NOTE: The MEGA 360 Imaging transducer can be connected in conjunction with HW, HW/MEGA DI+, HW/MEGA DI+/MEGA SI+ transducers, as well as built-in MEGA DI+ and built-in MEGA SI+ from a Minn Kota trolling motor.



NOTE: The MEGA 360 Imaging transducer can be connected to a SOLIX unit and shared with other SOLIX units over the Ethernet, or the MEGA 360 can be connected to a HELIX G3N unit and shared with other HELIX G3N and G2N units over the Ethernet.

SOLIX Series Networking

When you select the MEGA 360 Imaging transducer on the network, the related views and menus will be added to the control head.

Open the Sonar Source Menu

1. Press the HOME key.
2. Select Settings.
3. Select CHIRP Sonar.
4. Select Sonar Source.

Select Sonar Sources

Use the instructions in this section to assign sonar sources to each control head. The sonar sources can be shared between control heads or you can use different sonar sources on each control head.

1. From the Sonar Source menu, select the tab for the sonar source you want to assign.
The MEGA 360 Imaging transducer will be displayed on the Side Imaging and 360 Imaging tabs.
2. Select the transducer connection location. The connection locations are displayed as follows:



Selected Control Head [Local]: the control head you are actively using



Remote Control Head: additional control heads connected to the network



Black Box Sonar

3. Repeat steps 1 and 2 for each tab. You can select one sonar source on each tab.
When you turn on/off pinging or change the transducer settings, all control heads sharing the transducer are affected.

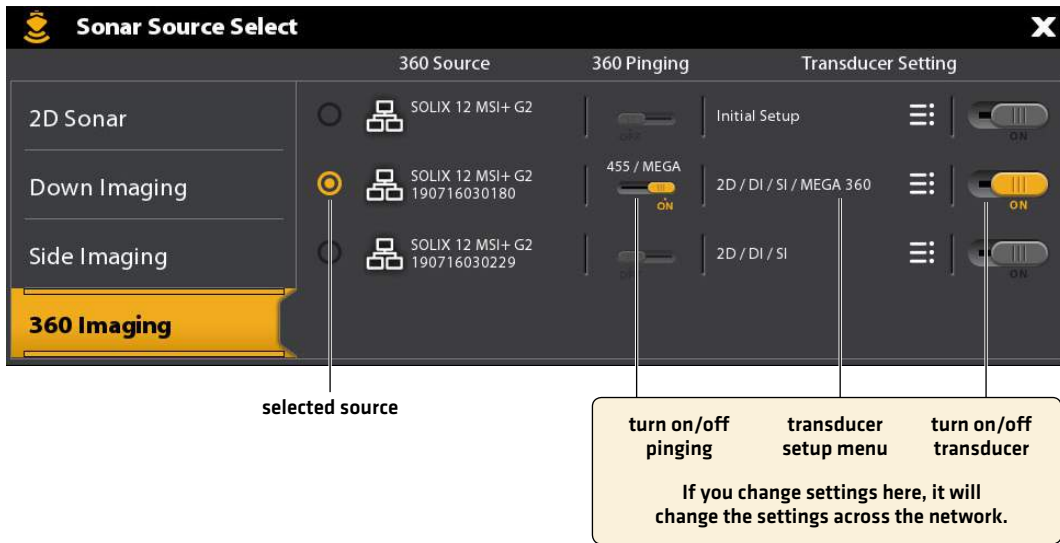

HELIX Series Networking

Open the Network Source Setup Dialog Box

1. **Main Menu:** Press the MENU key twice.



NOTE: If a System View is displayed on the screen, you will only need to press the MENU key once to open the Main Menu.

2. Select the Network tab.
3. Select Network Source Setup. Press the RIGHT Cursor key.

Opening the Network Source Setup Dialog Box (HELIX)

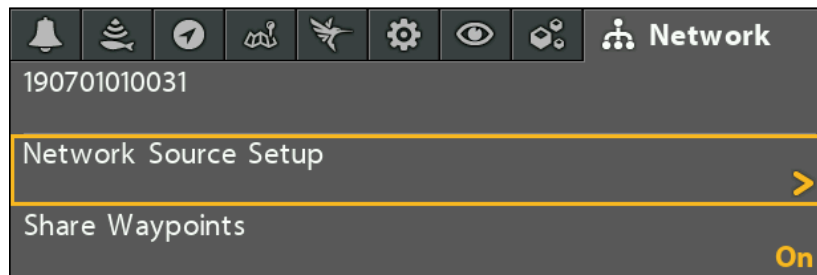

Status Tab: Review the status tab to see all detected sources in the network. If a source is grayed out, the source is detected, but the connection is lost or unavailable.

Select a Source: Review each source section to select a data source for each control head.

Network Source Setup Dialog Box (HELIX)

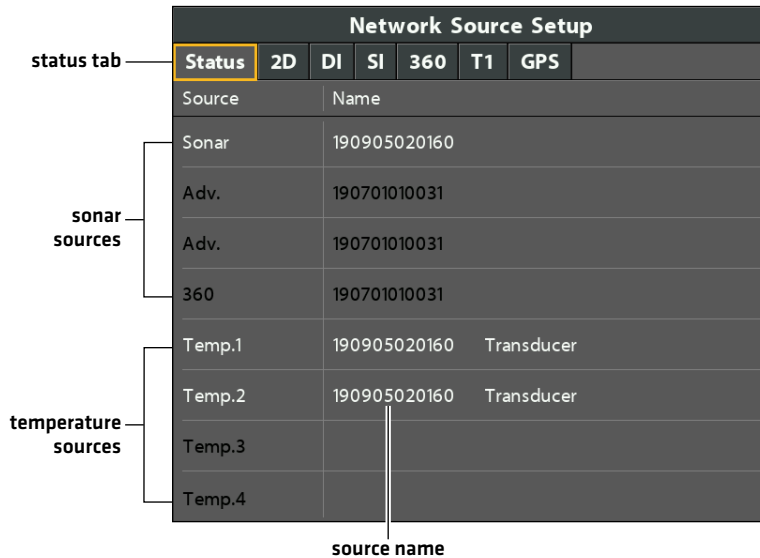

Select a Sonar Source

In addition to the MEGA 360 Imaging transducer, you may have another Humminbird transducer connected directly to the control head and/or available in a Humminbird multiple-control head Ethernet network. **The MEGA 360 Imaging transducer does not provide depth or temperature data**, so they must be provided by another transducer.

The sonar and temperature sources may be auto-populated in the Network Source Setup dialog box, but it is important to confirm that the source selections match your transducer and frequency preferences. You can use the Network Source dialog box to change the sonar source.

1. **Network Source Setup Dialog Box:** Select the Network tab > Network Source Setup. Press the RIGHT Cursor key.
2. Use the Cursor Control key to select a tab and choose a source. Press the CHECK/INFO key to select the source as follows:

2D Traditional Sonar	Select the 2D tab and select a 2D sonar source for the traditional sonar views.
Down Imaging	Select the DI tab and select a Down Imaging sonar source.
Side Imaging	Select the SI tab and select a Side Imaging sonar source. If there is a Side Imaging transducer connected to the control head, it will only be able to display 2D and Down Imaging data. Side Imaging data can be provided by the MEGA 360 beam.
MEGA 360 Imaging	Select the 360 tab and select the MEGA 360 Imaging source.
Temperature Data	The MEGA 360 Imaging transducer does not provide temperature. Select a Temperature tab [T1, T2, etc.] and select a temperature source or use the default temperature source.
GPS Receiver/Heading Sensor	Select the GPS tab and select the sensor that is attached to the control head. The type will be listed as Ext [externally connected]. A GPS Receiver/Heading Sensor is required for the MEGA 360 Imaging navigation features.

A checkmark will display in the box to show it is selected.

Selecting the MEGA 360 Imaging Transducer (HELIX)

Press the RIGHT or LEFT Cursor keys to select a tab.

Status	2D	DI	SI	360	GPS	
Name	Model				kHz	
190701010031	HELIX 8 CHIRP MEGA SI+ GPS G3N			MEGA 360	455/MEGA	<input checked="" type="checkbox"/>

Use the Cursor Control key to choose the transducer, and press the RIGHT Cursor key or the CHECK/INFO key to select it.

Selecting the Temperature Source (HELIX)

available sources

Status	2D	DI	SI	360	Temp.1	T2	GPS	
Name	Model			Source				
190701010031	HELIX 8 CHIRP MEGA SI+ GPS G3N			Transducer				<input type="checkbox"/>
190905020160	HELIX 10 CHIRP GPS G3N			Transducer				<input checked="" type="checkbox"/>

Use the Cursor Control key to choose the transducer, and press the RIGHT Cursor key or the CHECK/INFO key to select it.

 **NOTE:** If the control head is not capable of displaying a certain frequency from a transducer on the network, NONE will be displayed in the beam frequency column in the Network Source Setup dialog box.

 **NOTE:** The availability of beams is determined by the type of transducer that is connected to the control head and your Humminbird model. If a connected transducer is not displayed in the Network Source Setup dialog box, select the Main Menu > Sonar tab > Transducer Select or Connected Transducer, and set the transducer type.

 **NOTE:** If you have questions about which transducers are compatible with your control head, visit our Web site at humminbird.com or contact Humminbird Technical Support at **1-800-633-1468**.

3. **Close:** Press the EXIT key until the dialog box is closed.

Start/Stop MEGA 360 Imaging Operation

Use the instructions in this section to start and stop the MEGA 360 Imaging ping.

Start Pinging

The transducer pod deploys into the water with the trolling motor. You can then start pinging from the 360 View or from the Menu System.

Start Pinging from a 360 View

When a MEGA 360 Imaging transducer is connected to the control head, the 360 View will be automatically added to the view database.

SOLIX Series

1. Tap the view widget icon in the side bar.
2. Tap 360 Imaging.

Pinging from a 360 View (SOLIX)

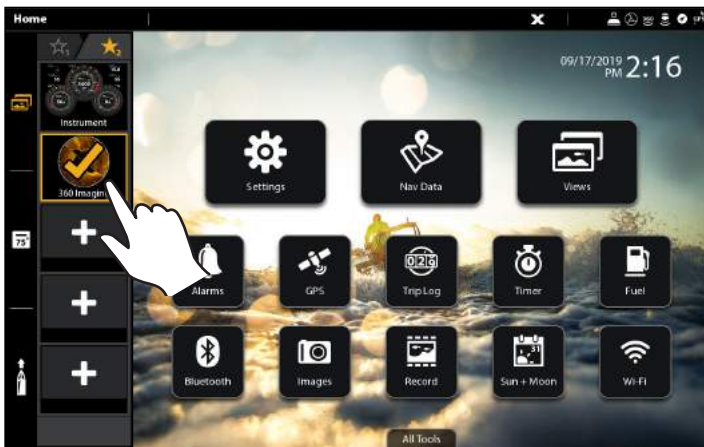

HELIX Series

1. Press the VIEW key until a 360 View or 360 Imaging Combo View is displayed on the screen.

Pinging from a 360 View (HELIX)

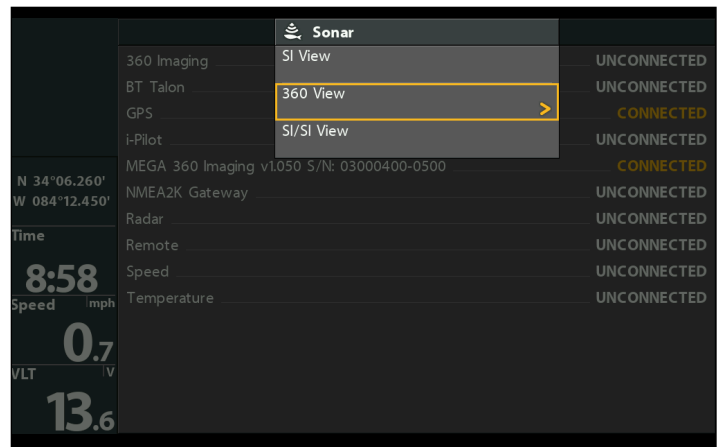

Start Pinging from the X-Press Menu

SOLIX Series

1. With the 360 View displayed on-screen, press the MENU key once, or tap Sonar [360] on the status bar.
2. Tap 360 Pinging or press the CHECK key.

Pinging from an X-Press Menu [SOLIX]

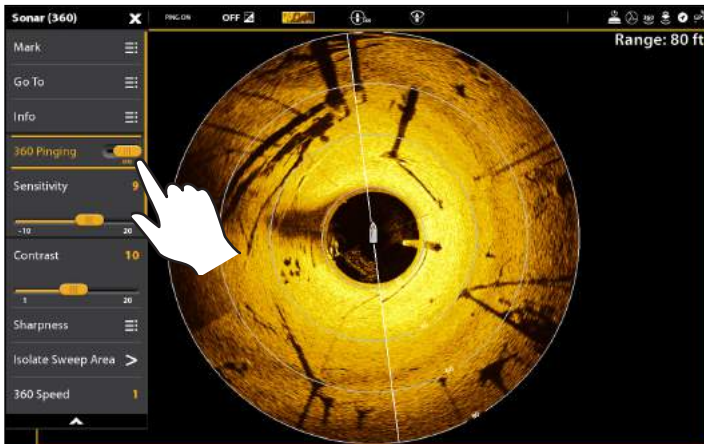

HELIX Series

1. With a 360 View or 360 Imaging Combo View displayed on the screen, press the MENU key once.
2. Select 360 Pinging, and press the RIGHT Cursor key to select On.

Pinging from an X-Press Menu [HELIX]

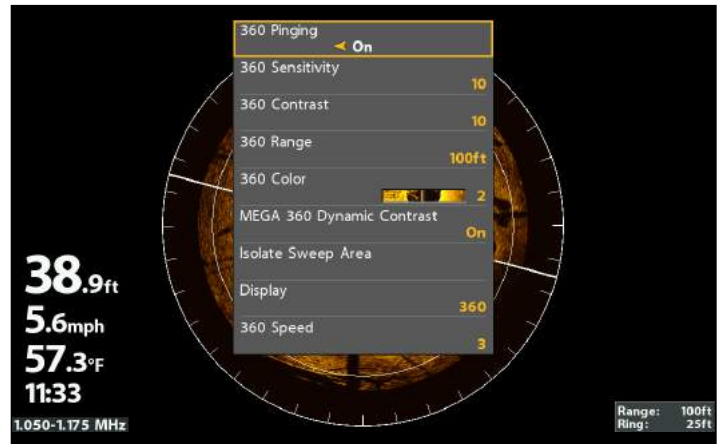

Start Pinging from the Status Bar (SOLIX only)

1. With a 360 View or 360 Imaging Combo View displayed on screen, tap PING ON on the MEGA 360 status bar.

Pinging On/Off from the Status Bar [SOLIX]



Start Pinging from the Power Submenu

You can also start pinging from the Power submenu.

SOLIX Series

1. Press the POWER key.
2. Tap Sonar.
3. Select 360 Pinging. Tap the On/Off button, or press the ENTER key, to turn it on.

Pinging from the Power Submenu [SOLIX]



HELIX Series

1. Press the POWER key.
2. Select 360 Pinging, and press the RIGHT Cursor key to select On.

Pinging from the Power Submenu [HELIX]

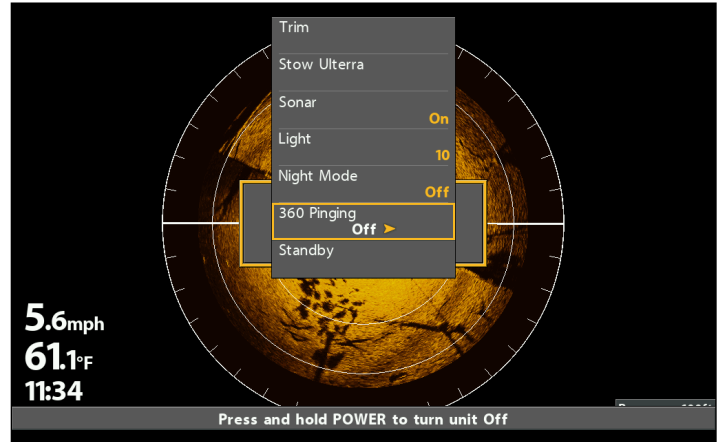

Stop Pinging

It is important to stop pinging the MEGA 360 Imaging transducer when it is not in use.

Stop Pinging from the X-Press Menu

SOLIX Series

1. With the 360 View displayed on-screen, press the MENU key once, or tap Sonar [360] on the status bar.
2. Select 360 Pinging. Tap the On/Off button, or press the ENTER key, to turn it off.

HELIX Series

1. With a 360 View or 360 Imaging Combo View displayed on the screen, press the MENU key once.
2. Select 360 Pinging, and press the LEFT Cursor key to select Off.

Stop Pinging from the Status Bar (SOLIX only)

1. With a 360 View or 360 Imaging Combo View displayed on the screen, tap PING OFF on the MEGA 360 status bar.

Pinging On/Off from the Status Bar [SOLIX]



Stop Pinging from the Power Submenu

SOLIX Series

1. Press the POWER key.
2. Tap Sonar.
3. Select 360 Pinging. Tap the On/Off button, or press the ENTER key, to turn it off.

HELIX Series

1. Press the POWER key.
2. Select 360 Pinging, and press the LEFT Cursor key to select Off.

Wet Switch

The MEGA 360 wet switch automatically stops MEGA 360 pinging/rotation while the transducer is out of the water, in order to prevent wear and tear. Your control head will display the following message: MEGA 360 Disabled Out of the Water.

Out of the Water Notification (SOLIX)

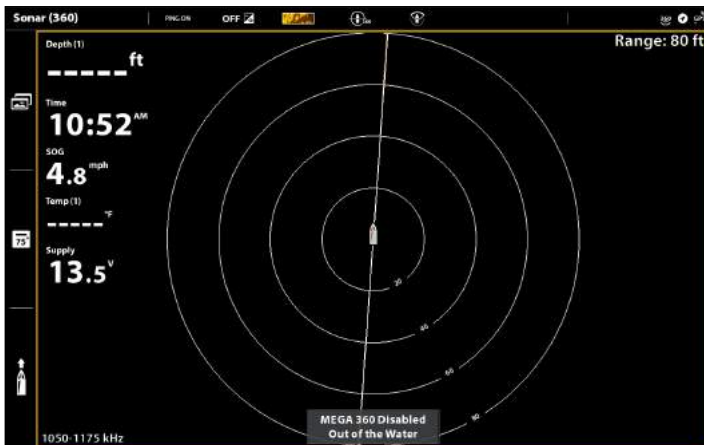

Out of the Water Notification (HELIX)

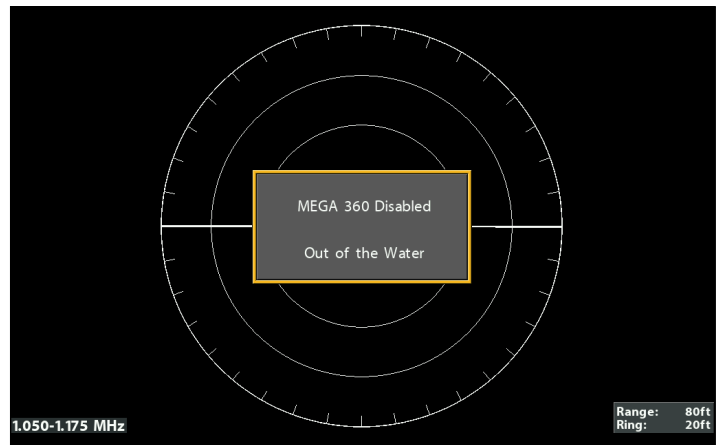

What's on the MEGA 360 Imaging Display

MEGA 360 Imaging uses its unique transducer to provide an unobstructed view of the water around and below your boat. The razor-thin, high-definition beams produce the detailed sonar data that you see on the display. MEGA 360 Imaging reveals a variety of recognizable features so that you can interpret the structure and bottom contour, and the following items in this illustration.

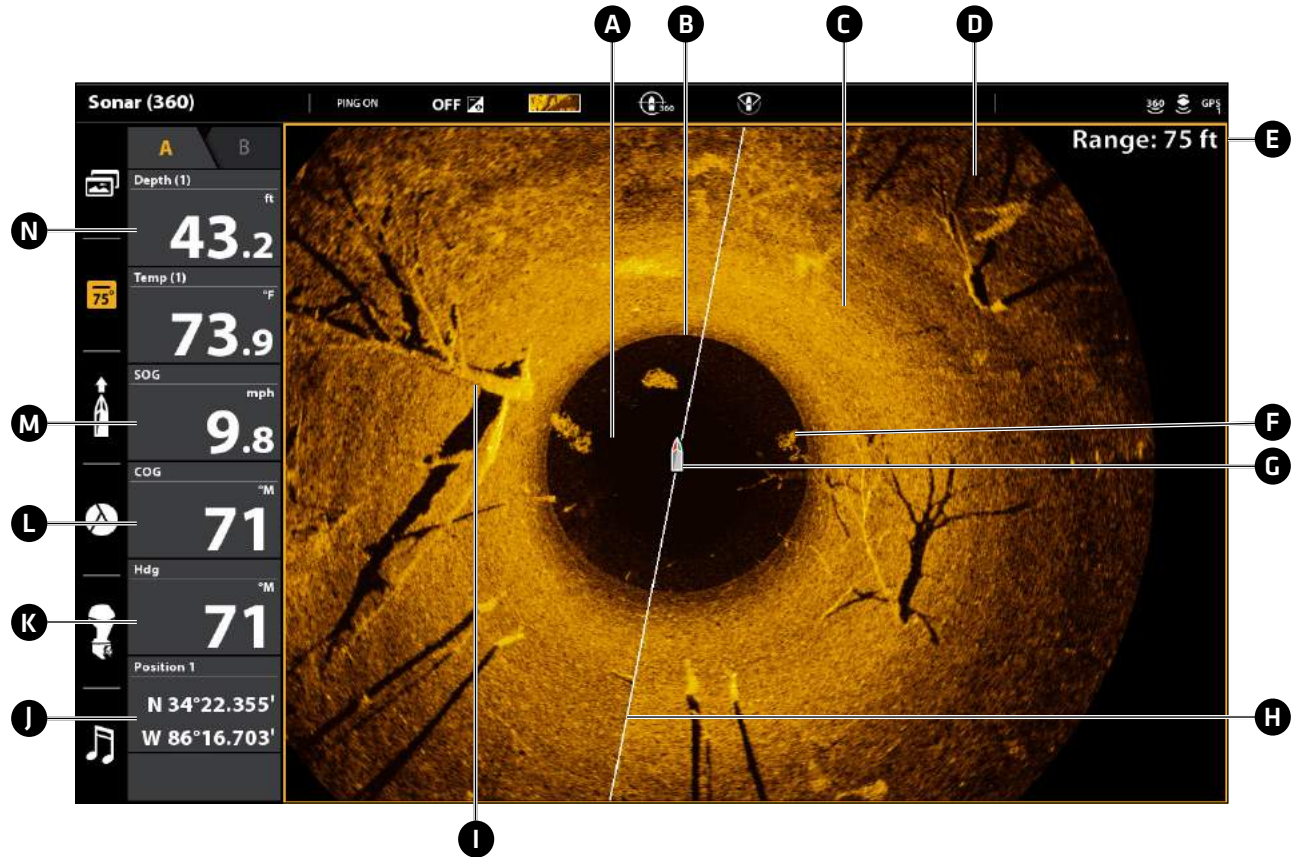

- A Water Column:** Shows the relative depth of the water under the boat at a given time. Variations in the width of the water column show variations in the distance to the bottom as the boat passes over.
- B Bottom Return**
- C Topography Changes [light]:** The light part of the display shows where the beams are hitting hard bottom or rising terrain.
- D Topography Changes [dark]:** Dark parts of the display indicate soft bottom [sand, mud] or descending terrain.
- E Range** is the 360 Range setting. See *Change the Sweep Speed and Range* for more information.
- F White streaks** may indicate fish and a clouded area may indicate a bait ball.
- G Boat Icon:** The boat icon can be set to hidden or visible on the view. See *Change the 360 View Display Settings*.
- H Sweep Line:** As the sweep line rotates on the view, it reveals the sonar returns from the MEGA 360 Imaging beams.
- I Structure:** Possible vegetation where fish may be hiding.
- J Position:** The boat's current latitude/longitude location determined by GPS.
- K Heading:** The boat's heading measured in degrees from North, where 000° is North, 090° is East, 180° is South, and 270° is West [compass/heading sensor required].
- L Course:** The current direction the boat is traveling measured in degrees from North, where 000° is North, 090° is East, 180° is South, and 270° is West [GPS required].
- M Speed:** The measurement of the boat's progress across a given distance [GPS required].
- N Depth:** The depth of the water as provided by another attached transducer [see *Set Up MEGA 360 on the Network*].

MEGA 360 Imaging Views

SOLIX Series Views

When the MEGA 360 Imaging transducer is set up on the control head, the 360 View is added to the Favorite Views widget, and additional combo views are available from the Views tool.

SOLIX View Options

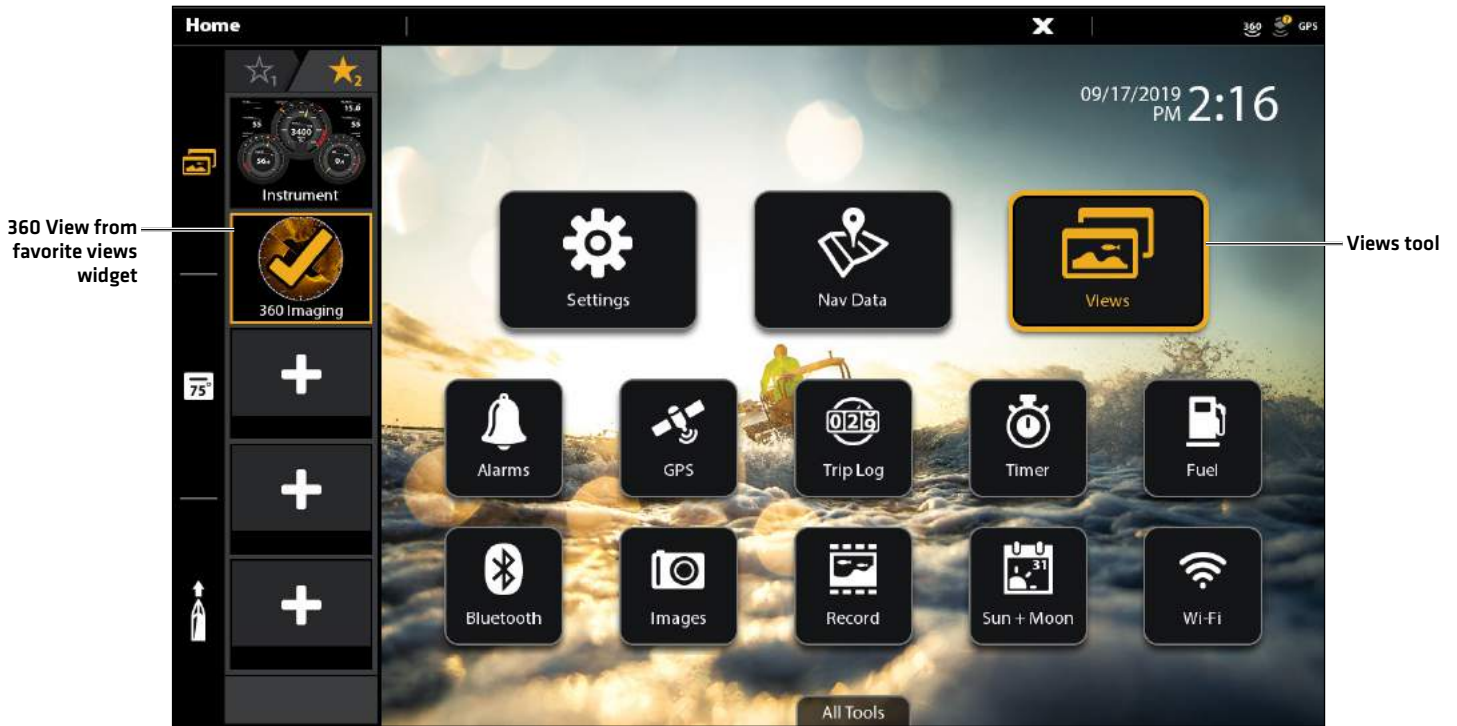

Display a View from the Views Tool

The Views tool includes the complete database of available views for your control head. Use the Views tool to create a new view and edit a view.

1. Press the HOME key.
2. Select the Views tool.
3. Select a Group. To see all available views, select All.
4. Tap the View.

OR

Use the Joystick to select a view. Press the ENTER key to display it on-screen.

Display a View from the Favorite Views Widget

1. Tap the views widget icon in the side bar.
2. Tap a view to display.

OR

1. Press the Rotary dial.
2. Use the Joystick to select a view to display. Press the ENTER key.

View Options

The View Options menu provides options to edit the selected view. You can open the View Options menu from the on-screen view or from the Views tool on the Home screen. The View Options menu for MEGA 360 Imaging allows you to turn the side bar on or off, edit the view layout or name, and change the data overlays.

HELIX Series Views

When the MEGA 360 Imaging transducer is set up on the control head, the 360 View is added to the View Rotation.

 **NOTE:** The available views will depend on your control head model and the beams you've selected in the Network Source Setup dialog box. See **Set Up MEGA 360 on the Network** for details.



Next View: Press the VIEW key to advance to the next view in the View Rotation. Press the VIEW key repeatedly until the view you want to use is displayed on the screen.



Previous View: Press the EXIT key to see the previous view in the View Rotation. Press the EXIT key repeatedly until the view you want to use is displayed on the screen.

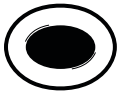

Save a View: Press and hold a VIEW PRESET key to save a shortcut to the on-screen view. You can save one view on each VIEW PRESET key. Press the VIEW PRESET key to quickly return to the view at any time.

Views X-Press Menu: Press and hold the VIEW key. Use the Cursor Control key to select a view category [Sonar, Chart, System, NMEA 2000, Radar] and a view. The Views X-Press Menu allows you to quickly access a view instead of scrolling through the View Rotation.

360 View

The 360 View allows you to see the MEGA 360 Imaging data on the full screen.

360 X-Press Menu	<p>The X-Press Menu allows you to start or stop pinging, adjust the beam range, change the color, isolate the sweep area, and customize the display.</p> <p>SOLIX: Tap Sonar [360] in the status bar or press the MENU key once.</p> <p>HELIX: Press the MENU key once.</p>
Cursor and Zoom	<p>SOLIX: Use the Joystick to move the cursor over a sonar return. Press the +ZOOM key or pinch and drag with your fingers to magnify the view.</p> <p>HELIX: Use the Cursor Control key to display the cursor and move it over a sonar return. Press the +ZOOM key to magnify the View. Press the EXIT key to remove the Cursor.</p> <p>See Zoom In/Out for more information.</p>
Mark and Display Waypoints	<p>You can mark and display waypoints on the 360 View. See Mark and Display Waypoints.</p>
Digital Readouts	<p>Digital Readout data can be displayed on-screen as an overlay or in data boxes.</p> <p>SOLIX: To change the overlay displayed on the screen, press the MENU key once, or tap Sonar [360] in the status bar, and then select View Options > Data Overlays. To change a data bar, press the PANE key once and select the type of data bar to display from the side bar. To keep the data bar displayed on the view, tap the pin icon at the bottom of the data bar. Press and hold a data box to edit it.</p> <p>HELIX: To change the readouts that are displayed on the 360 View, select the Main Menu > Setup tab > Select Readouts. Use the Cursor Control key to select a Readout position and set the information that will be displayed in each digital readout window.</p>

NOTE: Digital readouts may change with the selected view, attached accessories, and whether or not the control head is navigating. See your control head operations manual and the Operations Summary Guide for details.

360 View (SOLIX)



360 View (HELIX)

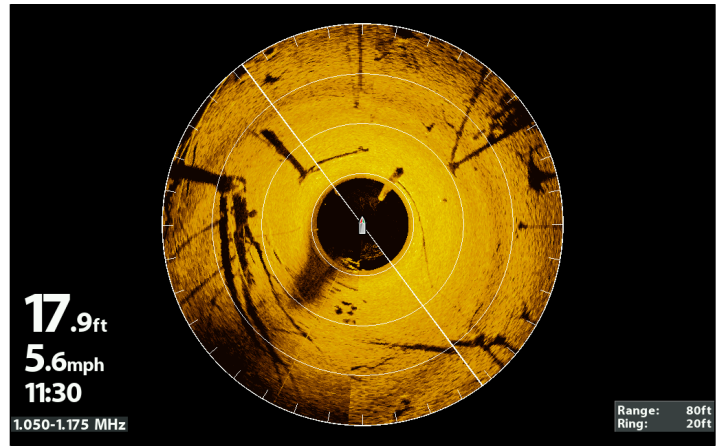

360/Sonar Combo View

The 360/Sonar Combo View shows sonar information and MEGA 360 Imaging information in a combination split screen, where the Sonar View is displayed on the left and the 360 View is displayed on the right.

<p>Active Side</p>	<p>SOLIX: The selected pane is outlined in yellow. Tap a pane or press the PANE key to select a pane.</p> <p>HELIX: The arrow points to the active side. Press the MENU key once and select Active Side from the X-Press Menu. Choose RIGHT or LEFT to set the active side.</p>
<p>X-Press Menu</p>	<p>After you set the Active Side, press the MENU key once to open the X-Press Menu. The X-Press Menu provides menu options for the active view.</p> <p>NOTE: On SOLIX, you can also access the X-Press Menu by tapping the menu in the status bar.</p>
<p>Sonar</p>	<p>Use the 2D traditional Sonar View with the 360 View to maximize your sonar data.</p>

360/Sonar View (SOLIX)

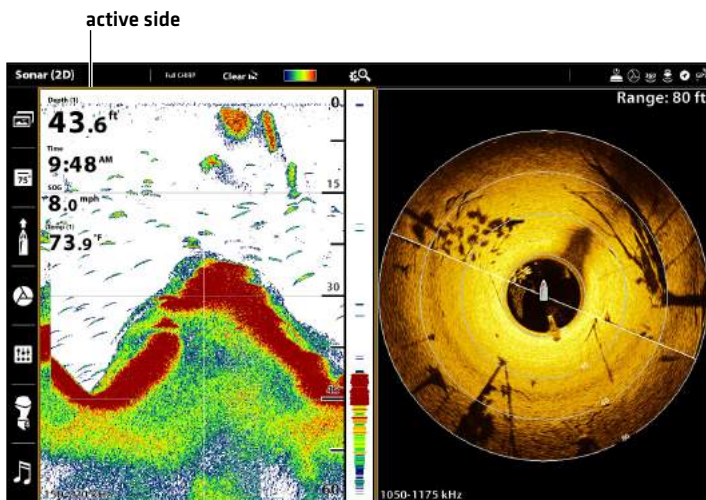

360/Sonar View (HELIX)

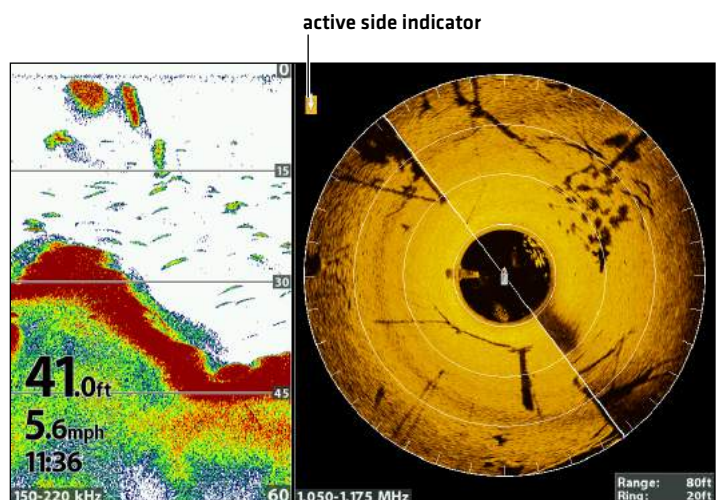

360/Chart Combo View

The 360/Chart Combo View shows chart information and 360 Imaging sonar information in a combination split screen, where the Chart View is displayed on the left and the 360 View is displayed on the right.

<p>Active Side</p>	<p>SOLIX: The selected pane is outlined in yellow. Tap a pane or press the PANE key to select a pane.</p> <p>HELIX: The arrow points to the active side. Press the MENU key once and select Active Side from the X-Press Menu. Choose RIGHT or LEFT to set the active side.</p>
<p>X-Press Menu</p>	<p>After you set the Active Side, press the MENU key once to open the X-Press Menu. The X-Press Menu provides menu options for the active view.</p> <p> NOTE: On SOLIX, you can also access the X-Press Menu by tapping the menu in the status bar.</p>
<p>Navigation</p>	<p>Use the Chart View with the 360 View to determine the position of structure and fish. To mark waypoints on the 360 View, see <i>Mark and Display Waypoints</i>.</p>

360/Chart View (SOLIX)

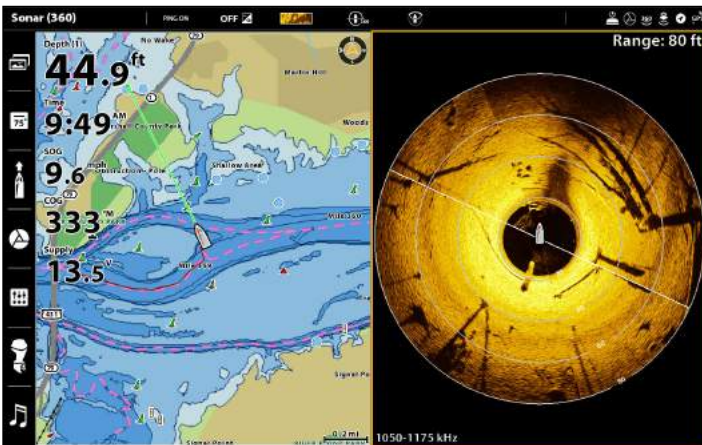

360/Chart View (HELIX)

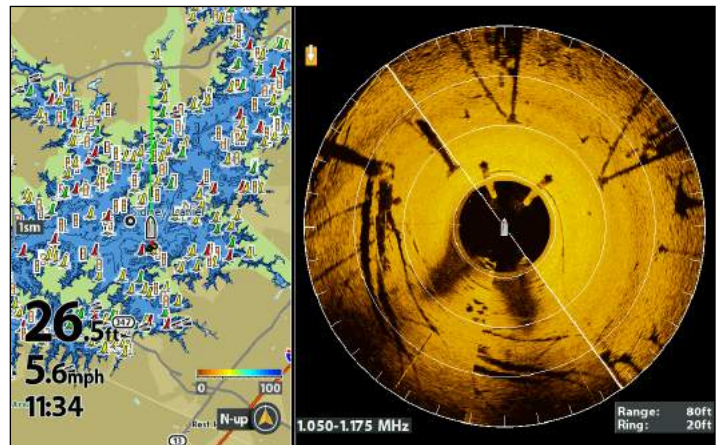

Side Imaging View

If a MEGA 360 Imaging transducer or a Side Imaging transducer is connected to the control head, the Side Imaging View will be available in the database of available views. It is also important to understand the following:

<p>SI Source</p>	<p>You may have different SI view options, depending on your setup and network.</p> <p>MEGA 360 Imaging transducer: The MEGA 360 Imaging transducer will automatically be configured as the Side Imaging sonar source. You can switch between 360 and Side Imaging views. An on-screen alert will display before switching between MEGA 360 mode and Side Imaging mode.</p> <p>MEGA 360 Imaging and Side Imaging transducers: If there is a MEGA 360 Imaging transducer and a Side Imaging transducer connected to the control head with a splitter cable (y-cable), the Side Imaging transducer will only display high wide and MEGA Down Imaging data. However, you can use the MEGA 360 Imaging transducer to provide the Side Imaging beam data for the Side Imaging Views [see Set Up MEGA 360 on the Network]. You can switch between 360 and Side Imaging views. An on-screen alert will display before switching between MEGA 360 mode and Side Imaging mode.</p>
<p>Start Side Imaging</p>	<p>SOLIX: Tap the View widget icon in the side bar and select a Side Imaging view. If you are switching from MEGA 360 mode to Side Imaging mode, an on-screen alert will display. Tap the right arrow to begin Side Imaging operation.</p> <p>HELIX: Press and hold the VIEW key. Select Sonar > Side Imaging. If you are switching from MEGA 360 mode to Side Imaging mode, an on-screen alert will display. Press the RIGHT Cursor key to start Side Imaging operation.</p>
<p>SI Range and 360 Range</p>	<p>If the MEGA 360 Imaging transducer is providing data for the Side Imaging Views, the 360 Range setting and the SI Range setting will be shared. When you change the 360 Range setting, the SI Range setting will also be changed, and vice versa.</p>
<p>More Information</p>	<p>See your control head operations manual and Operations Summary Guide for more information about Side Imaging. These manuals were included with your control head, or they can be downloaded from our Web site at humminbird.com.</p>



NOTE: The MEGA 360 Imaging transducer provides data for the 360 View OR the Side Imaging View. These views cannot be displayed at the same time if they are sharing the MEGA 360 Imaging transducer in a multiple-control head Ethernet network.

Side Imaging Mode On-screen Alert (HELIX)

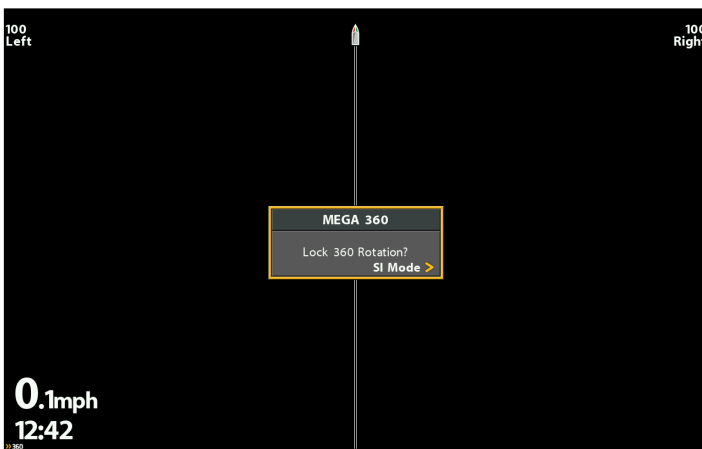

Side Imaging from MEGA 360 Transducer (HELIX)

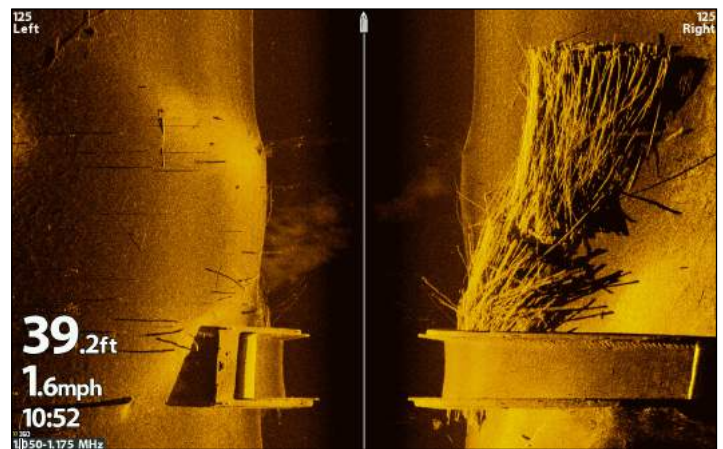

MEGA 360 transducer indicator

Change the 360 View Display Settings

Use the following instructions to change how the 360 View is displayed.

Change the Display Settings

SOLIX Series

1. **X-Press Menu:** With the 360 View displayed on-screen, press the MENU key once, or tap Sonar [360] on the status bar.
2. Select Sonar Options.
3. Tap the screen or use the Joystick to select an option from the submenu.

Preferences	<p>The Preferences submenu allows you to set the sonar color, 360 orientation offset, and activate contour mode.</p> <p>Sonar Colors: The Sonar Colors submenu changes the colors used to display sonar returns on the view.</p> <p>360 Orientation: If the position of objects on the display are slightly different than what you observe in the environment around you, use this menu option to rotate the display and correct the alignment. See the <i>MEGA 360 Imaging Installation Guide</i> for more information.</p> <p>Contour Mode: Contour Mode controls how the water column is displayed. When Contour Mode turned off, the water column is displayed on the view. The location of a target on the display is based on the slant range to the target.</p> <p>When Contour Mode is turned on, the bottom is graphed at a constant point on the display, regardless of changes in depth. The water column is removed from the view. The location of a target may be easier to interpret when the water column is removed.</p>
Overlays	<p>Use the Overlays submenu to display or hide information on the view. In the 360 View, you can display the following: boat icon, range rings and labels, beam frequency label, zoom label, compass, heading line, waypoints, and cursor data.</p> <p>Tap the menu, or use the Joystick to select an item, and add a check mark [check mark = visible, blank = hidden].</p>
Global	<p>When Global is turned on, the selected menu setting on the control head is shared with the other control heads in the network.</p> <p>When Global is turned off, the selected menu setting is only available on the selected control head.</p>
Range Marker	<p>To mark a specific range on the view, turn on Range Marker. Press and hold the slider to adjust the setting.</p>

4. **Close:** Tap the X icon.

MEGA 360 Sonar Options (SOLIX)



HELIX Series

1. **Main Menu:** Press the MENU key twice.
2. Select the Accessories tab > 360 Sonar Settings.
3. Use the Cursor Control key to select an option from the submenu, and press the RIGHT or LEFT Cursor keys to change the menu setting, as follows:

360 Range Overlay	Select On to display the range rings on the view, or select Off to hide the range rings.
360 Heading Offset	If the position of objects on the display are slightly different than what you observe in the environment around you, use this menu option to rotate the display and correct the alignment. See the <i>MEGA 360 Imaging Installation Guide</i> for more information.
360 Boat Icon	Select On to display the boat icon, or select Off to hide the boat icon.
Navigation on 360	To mark and display waypoints on the 360 View, select On. See <i>Mark and Display Waypoints</i> for more information.
360 Offset	The 360 Offset Icon represents the installation location of the GPS Receiver/Heading Sensor. Adjust the setting to match the distance between the 360 Imaging transducer and the GPS Receiver/Heading Sensor. See the <i>MEGA 360 Imaging Installation Guide</i> for more information.

4. **Close:** Press the EXIT key until the Menu System is closed.

MEGA 360 Display Settings (HELIX)

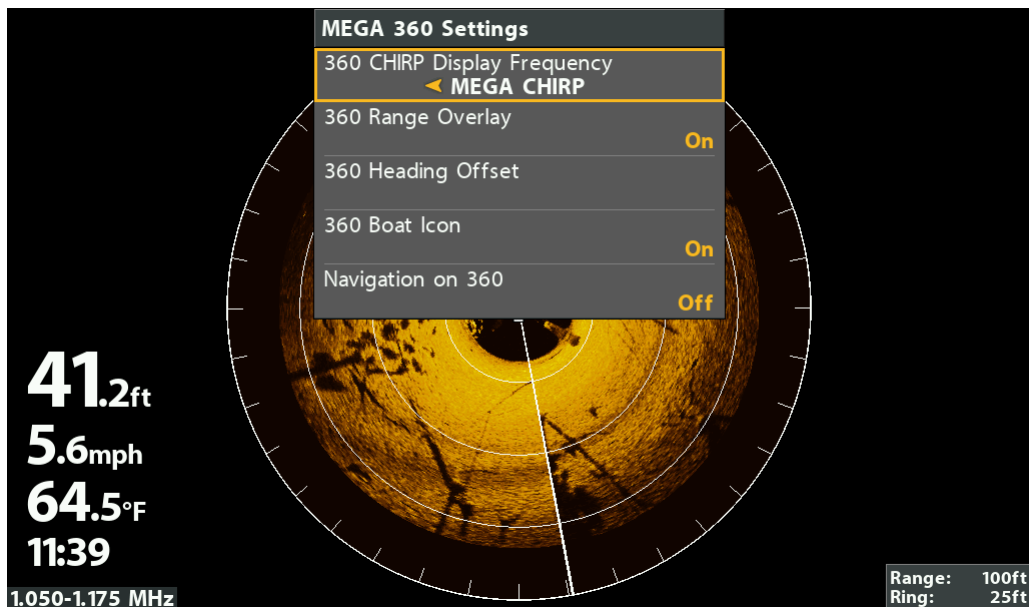

Change the View Color

The MEGA 360 Imaging X-Press Menu allows you to quickly change the display palette while you fish.

 **NOTE:** The palette you choose will be applied to all 360 Views in the View database.

SOLIX Series

1. **X-Press Menu:** With the 360 View displayed on-screen, press the MENU key once, or tap Sonar [360] on the status bar.
2. Select Sonar Colors.
3. Tap a sonar color palette, or use the Joystick to select a palette.
4. **Close:** Tap the X icon.

 **QUICK TIP!** This setting can also be changed in the status bar menu.

HELIX Series

1. **X-Press Menu:** With a 360 Imaging View displayed on-screen, press the MENU key once.
2. Select 360 Color.
3. Press the RIGHT or LEFT Cursor Keys to select a palette.
4. **Close:** Press the EXIT key.

Adjusting the Color (SOLIX)

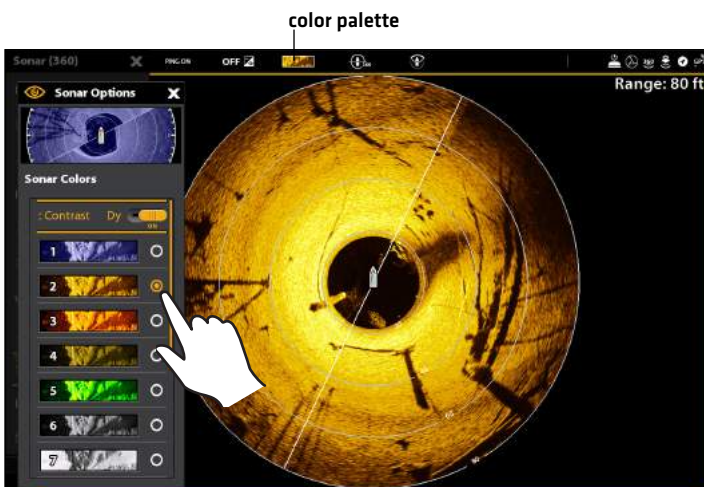

Adjusting the Color (HELIX)

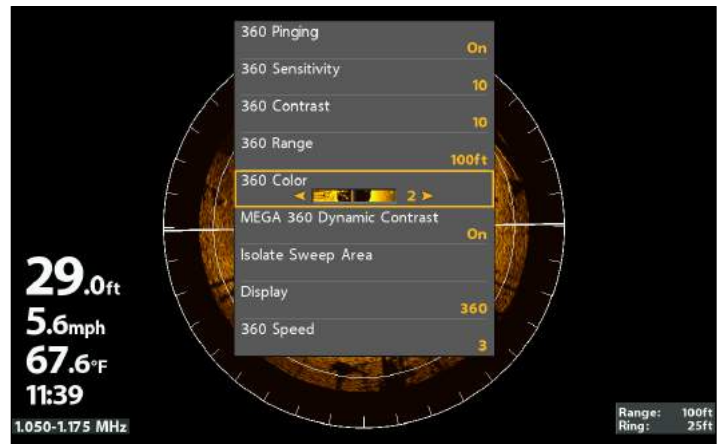

Customize the View

Customize the 360 View on SOLIX Series

The X-Press Menu provides menu options to adjust the sensitivity, contrast, sharpness, and water column sensitivity as you fish.

1. With a 360 View displayed on-screen, tap Sonar [360] in the status bar, or press the MENU key once.
2. Select Sensitivity, Contrast, or Sharpness.
3. Press and hold the slider, or turn the Rotary dial, to adjust the setting.

Sensitivity	Sensitivity controls how much detail is shown on the display and will adjust the sensitivity of all sonar frequencies. Decrease the sensitivity to eliminate the clutter from the display that is sometimes present in murky or muddy water. When operating in very clear water or greater depths, increase the sensitivity to see weaker returns that may be of interest.
Contrast	Adjust the Contrast setting to accent the light and dark parts of the MEGA 360 Imaging data to provide greater definition. When MEGA 360 Dynamic Contrast is turned on , the contrast will be automatically adjusted.
Sharpness	Turn on Sharpness and select a filter level to sharpen the edges of the MEGA 360 Imaging data.
Water Column Sensitivity	Increase or decrease the sensitivity of the sonar return that is in the water column. Decrease the sensitivity to reduce clutter and increase the sensitivity to see more sonar information.

MEGA 360 Sensitivity and Contrast Settings (SOLIX)

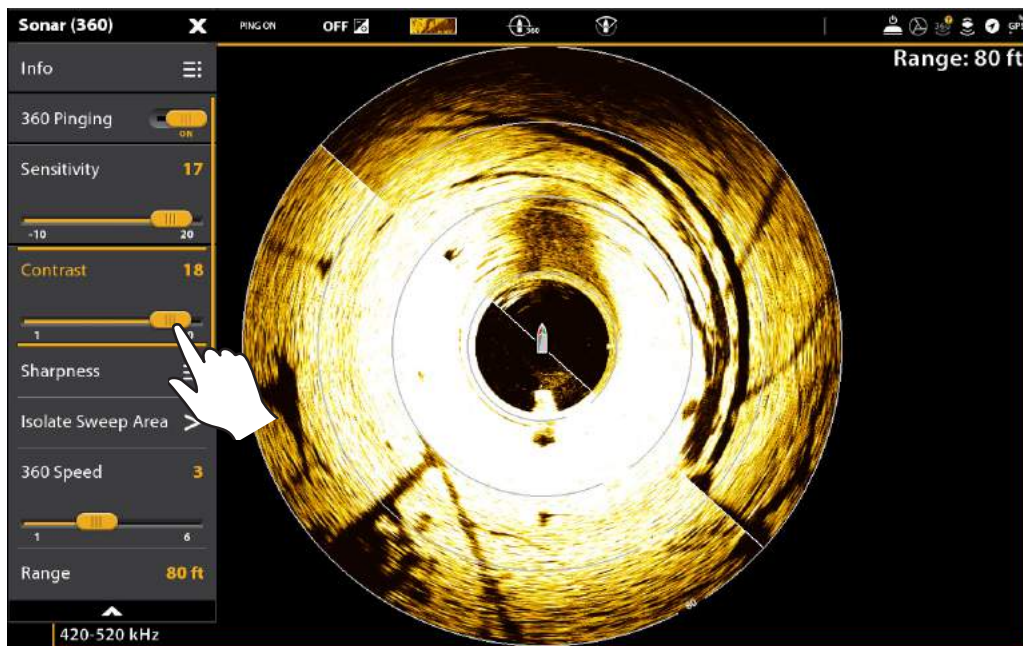

NOTE: The Sensitivity and Contrast are set high in the above illustration. The high Sensitivity setting displays more weak returns on the display, and the high Contrast setting shows more definition between the light and dark returns.

Adjust 360 Enhance Settings on HELIX Series

360 Enhance allows you to adjust the 360 View in four categories: Sensitivity, Contrast, Sharpness, and Contour Mode. The display will update as you adjust each category.

 **NOTE:** The User Mode must be set to Custom to see the 360 Enhance menu. In Angler Mode, you will only be able to adjust the sensitivity and contrast.

1. **X-Press Menu:** With the 360 View or Combo View displayed on the screen, press the MENU key once.
2. Select 360 Enhance.
3. Use the Cursor Control key to select and adjust the following settings:

Sensitivity	Controls how much detail is shown on the display. When operating in very clear water or greater depths, increase the sensitivity to show weaker returns that may be of interest. Decrease the sensitivity to eliminate the clutter from the display that is sometimes present in murky or muddy water.
Contrast	Accents the light and dark parts of the MEGA 360 Imaging data to provide greater definition. When MEGA 360 Dynamic Contrast is turned on , the contrast will be automatically adjusted.
Sharpness	Filters the view and sharpens the edges of the MEGA 360 Imaging data.
Contour Mode	Controls how the water column is displayed in the view. When Contour Mode is turned off , the water column is displayed on the view. The location of a target on the display is based on the slant range to the target. When Contour Mode is turned on , the water column is removed from the view, which allows the display to show targets at their linear horizontal distance. The location of a target may be easier to interpret when the water column is removed.

MEGA 360 Enhance Settings (HELIX)

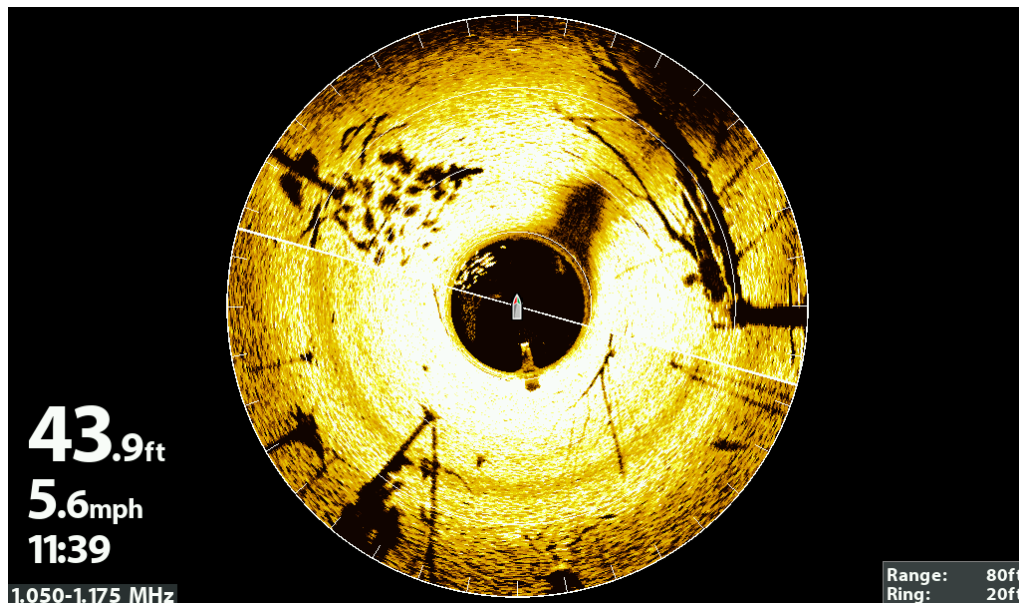

 **NOTE:** The Sensitivity and Contrast are set high in the above illustration. The high Sensitivity setting displays more weak returns on the display, and the high Contrast setting shows more definition between the light and dark returns.

Zoom In/Out

The ZOOM keys allow you to view the MEGA 360 display closer or farther away. You can also zoom in and out of a selected area based on the cursor position.

Activate the Cursor

SOLIX Series

1. Tap a position on the 360 View.

OR

Move the Joystick.

HELIX Series

1. Use the Cursor Control key to move the cursor to a position on the 360 View.
2. **Close:** Press the EXIT key to remove the Cursor.

Zoom In/Out

SOLIX Series

1. **Zoom In:** Tap the position twice [double tap].
2. **Zoom Out:** Tap the screen with two fingers once [single tap].

OR

1. **Zoom In:** Touch the screen with two fingers and move them apart [pinch out].
2. **Zoom Out:** Touch the screen with two fingers and move them together [pinch in].

OR

1. **Zoom In:** Press the +ZOOM key.
2. **Zoom Out:** Press the - ZOOM key.

HELIX Series

1. **Zoom In:** Press the +ZOOM key.
2. **Zoom Out:** Press the -Zoom key.

Zooming In (SOLIX)

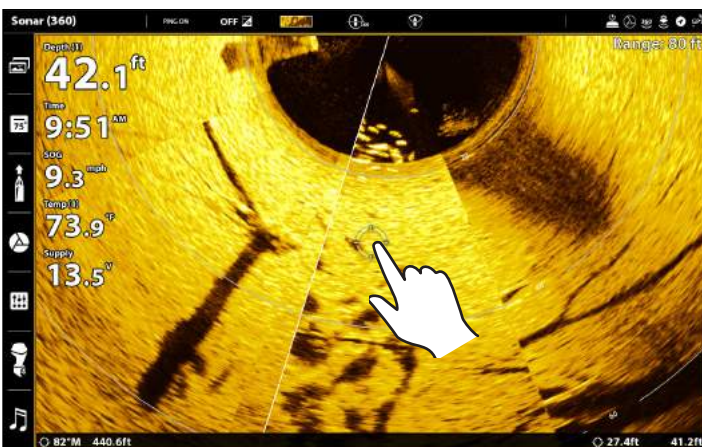

Zooming In (HELIX)

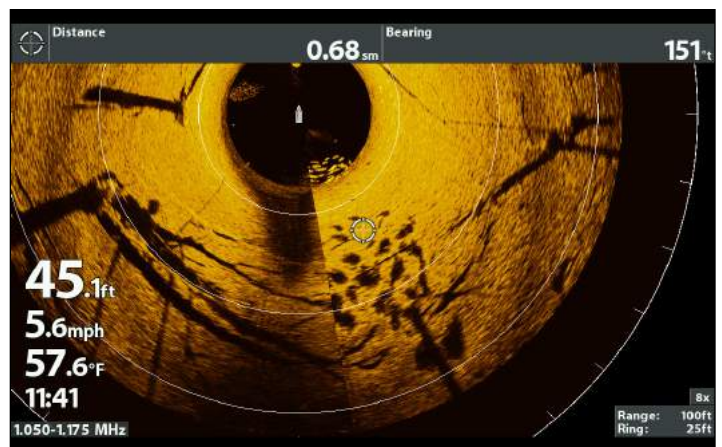

Change the Sweep Speed and Range

The 360 Imaging menu options allow you to change the sweep speed and range. The settings you use will influence how quickly the screen refreshes and how much detail is shown on the screen.

Change the Sweep Speed

The 360 Speed menu option allows you to adjust the speed of the sweep from six beam rotation speeds for the right balance of image quality and refresh rate. When the sweep speed is slower, more detail is shown on the screen. When the sweep is faster, more information is displayed but less detail is shown.

SOLIX Series

1. **X-Press Menu:** With a 360 View displayed on the screen, press the MENU key once, or tap Sonar [360] on the status bar.
2. Select 360 Speed.
3. Press and hold the slider, or press and hold the ENTER key, to set the 360 speed.

Changing the Sweep Speed [SOLIX]

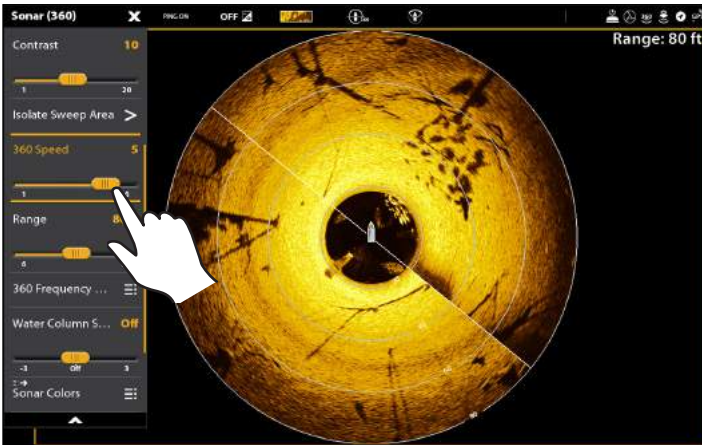

HELIX Series

1. **X-Press Menu:** With the 360 View or Combo View displayed on the screen, press the MENU key once.
2. Select 360 Speed.
3. Press the RIGHT or LEFT Cursor keys to select a sweep speed.

Changing the Sweep Speed [HELIX]

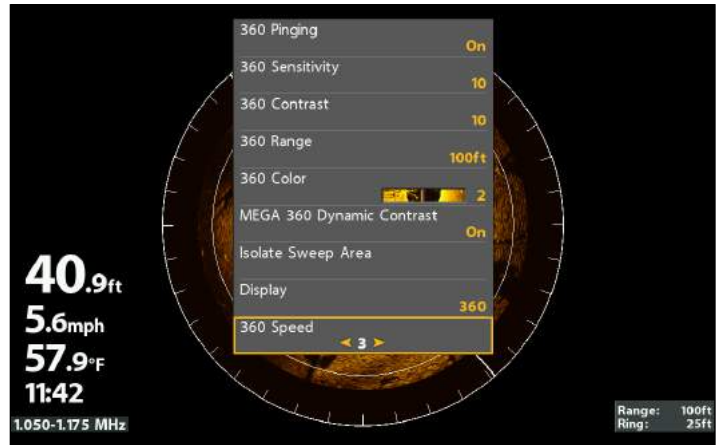

Change the 360 Range

360 Range controls how far the MEGA 360 Imaging beams will ping. Select a low range number to focus on a shorter distance of the water column and see greater detail on the screen. Select a higher range number to see farther into the water and see an overview of details on the screen. For optimal performance, select 80 feet.



NOTE: If the MEGA 360 Imaging transducer is providing data for the Side Imaging Views, the 360 Range setting will control the SI Range setting.

SOLIX Series

1. **X-Press Menu:** With a 360 View displayed on the screen, press the MENU key once, or tap Sonar [360] on the status bar.
2. Select 360 Range.
3. Press and hold the slider, or press and hold the ENTER key, to set the 360 range.



QUICK TIP! This setting can also be changed by turning the Rotary Dial.

HELIX Series

1. **X-Press Menu:** With the 360 View or Combo View displayed on the screen, press the MENU key once.
2. Select 360 Range.
3. Press the RIGHT or LEFT Cursor keys to adjust the range.

Adjusting the Range (SOLIX)

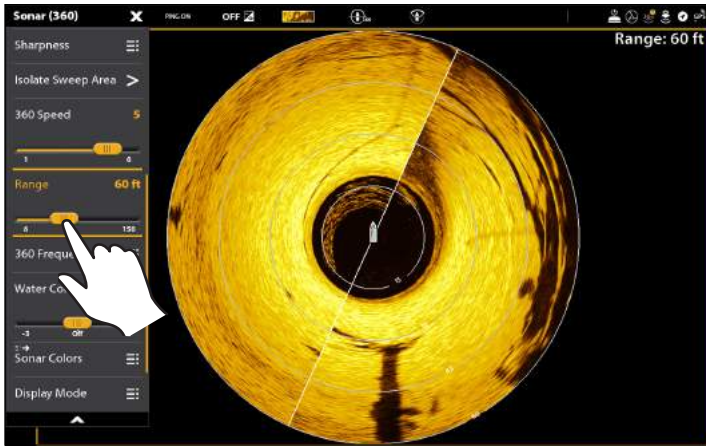

Adjusting the Range (HELIX)

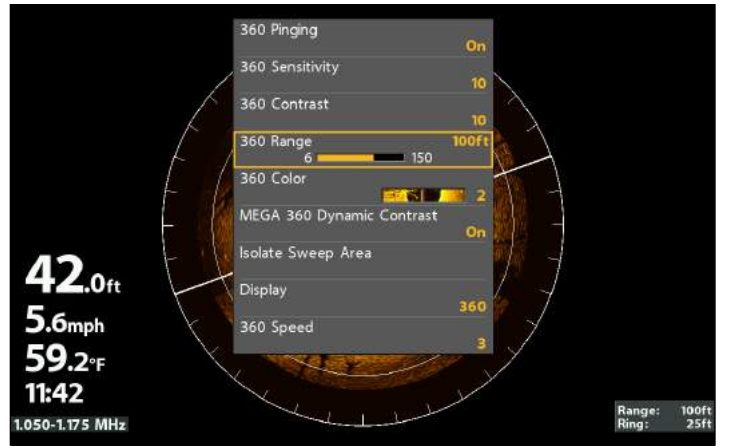

Isolate a Section of the Sweep

There are many options to focus on a section of the sweep. You can set the sweep angle and section yourself, from 360 degrees down to 10 degrees, or you can use a 45 degree preset section, like front, rear, left, and right.

Activate Quick Sweep

Use Quick Sweep to focus quickly on a section of the view. When the Quick Sweep area is set, the full 360 View will continue to display on-screen, but the sweep will only cover the angle you select.

SOLIX Series

1. **Set the 1st Limit:** Press and hold the CHECK key.
2. **Set the 2nd Limit:** Tap the Check in the status bar.
3. **Resume the Full 360 Sweep:** Tap the Full 360 icon in the status bar.

Activating Quick Sweep (SOLIX)

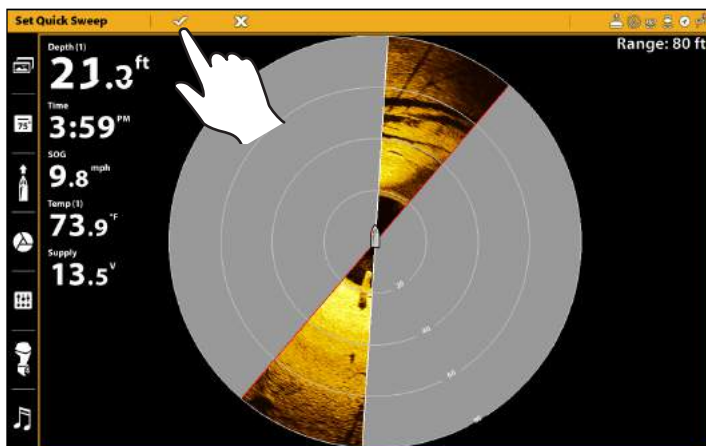

HELIX Series

1. **Set the 1st Limit:** Press the CHECK/INFO key.
2. **Set the 2nd Limit:** Press the CHECK/INFO key.
3. **Resume the Full 360 Sweep:** Press the CHECK/INFO key.

Activating Quick Sweep (HELIX)

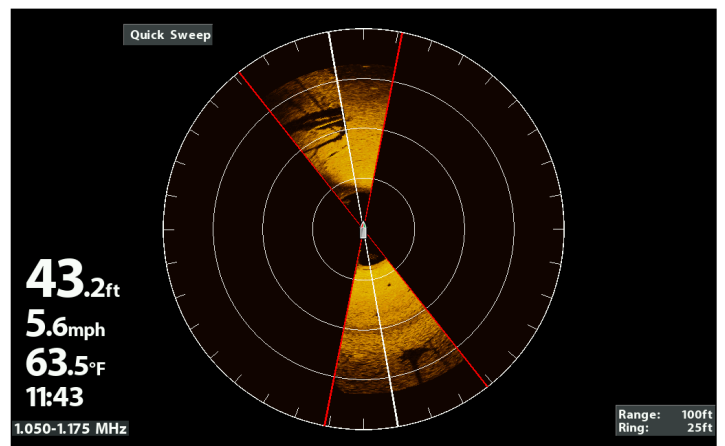

Isolate the Sweep Area

Isolating the sweep area allows you to focus the sweep on a section of the water. The sweep area can be set between 10° to 360°, and you can adjust it as you prefer.

SOLIX Series

1. **X-Press Menu:** With a 360 View displayed on the screen, press the MENU key once, or tap Sonar [360] on the status bar.
2. Select Isolate Sweep Area.
3. The sweep area can be adjusted as follows:
 - Adjust the Sweep Position:** Turn the Rotary Dial.
 - Adjust the Sweep Size:** Use the RIGHT and LEFT Cursor keys or press and hold to drag the double-sided arrows.
4. **Confirm the Selection:** Press the CHECK in the status bar.
5. **Close:** Select Resume Full Sweep from the X-Press Menu.

 **NOTE:** You can quickly return to your isolate sweep setting by tapping the Isolate Sweep icon in the status bar.

HELIX Series

1. **X-Press Menu:** With the 360 View or Combo View displayed on the screen, press the MENU key once.
2. Select Isolate Sweep Area. Press the RIGHT Cursor key.
3. The sweep area can be adjusted as follows:
 - Adjust the Sweep Position:** Press the RIGHT or LEFT Cursor keys.
 - Adjust the Sweep Size:** Press the UP or DOWN Cursor keys.
4. **Confirm the Selection:** Press the CHECK/INFO key.
5. **Close:** Select Resume Full Sweep from the X-Press Menu.

Isolating Sweep [SOLIX]

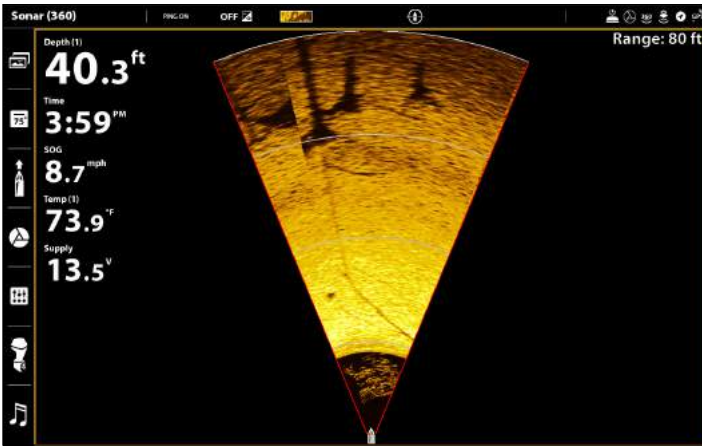

Isolating Sweep [HELIX]

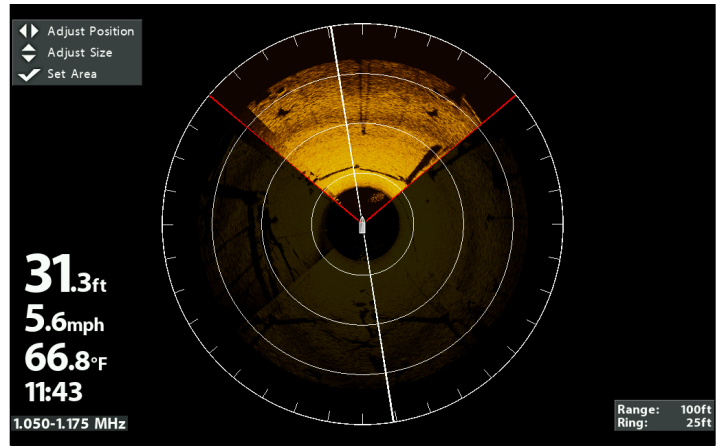

Select a Preset Display

Use the Display menu option to choose a preset portion of the MEGA 360 Imaging sweep. The preset display modes include 360, Front, Left, Right, and Rear.

 **NOTE:** If you use Isolate Sweep Area in this mode, the view will switch to the full 360 View.

SOLIX Series

1. **X-Press Menu:** With a 360 View displayed on the screen, press the MENU key once, or tap Sonar [360] on the status bar.
2. Select Display Mode.
3. Tap to select a display option.

 **NOTE:** You can also select a preset display by tapping the Display Mode icon on the status bar.

HELIX Series

1. **X-Press Menu:** With the 360 View displayed on the screen, press the MENU key once.
2. Select Display.
3. Press the RIGHT or LEFT Cursor keys to select a display option.

Left Sweep [SOLIX]

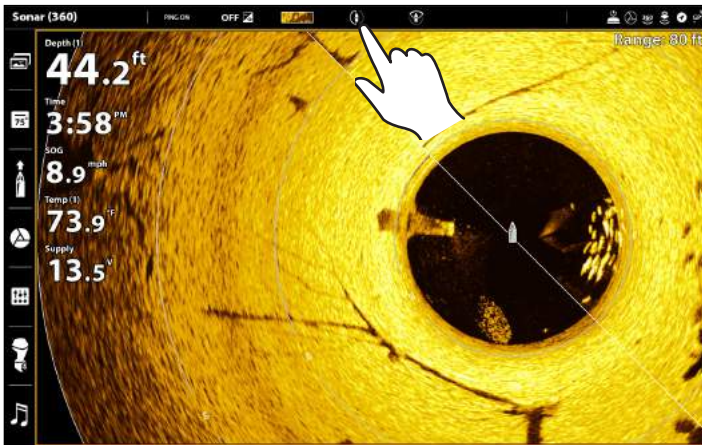

Left Sweep [HELIX]

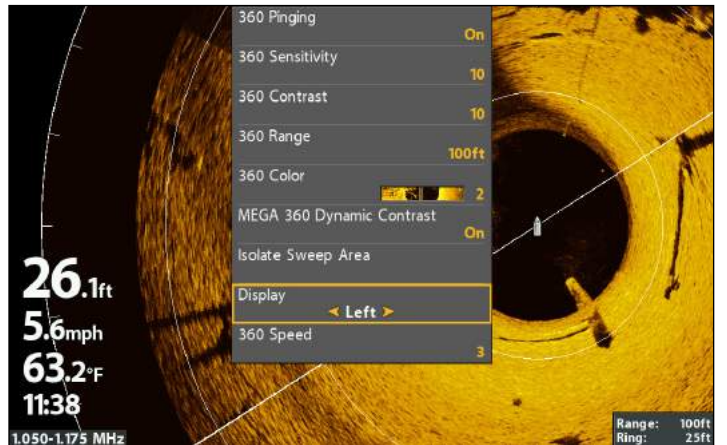

Change the Frequency

You can display the MEGA 360 Imaging transducer in two beam frequencies: 455 kHz and MEGA.

SOLIX Series

1. **X-Press Menu:** With a 360 View displayed on the screen, press the MENU key once, or tap Sonar [360] on the status bar.
2. Select 360 Frequency Select and Display.
3. Select a frequency from the list.

Changing the Frequency (SOLIX)

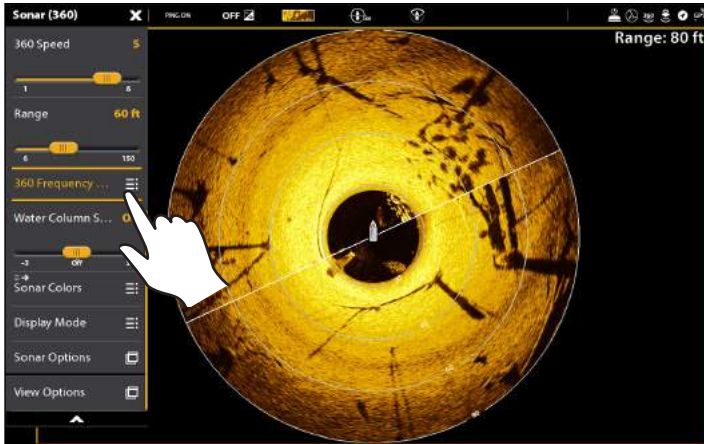

HELIX Series

1. **Main Menu:** Press the MENU key twice.
2. Select the Sonar tab > 360 CHIRP Display Frequency.
3. Use the RIGHT and LEFT Cursor keys to select a frequency from the list.

Changing the Frequency (HELIX)

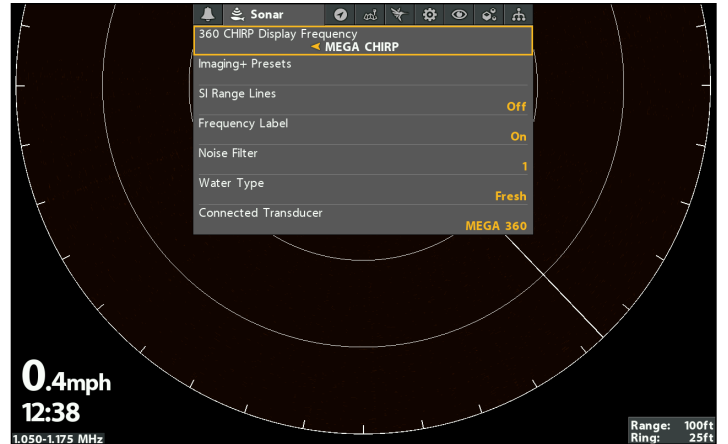

Mark and Display Waypoints

You can mark a waypoint directly on your Humminbird screen, and let the range rings show you the distance from your boat to the target. To mark waypoints and start navigation, the control head must have a GPS fix and a heading sensor [compass].

You can use the following navigation functions in a 360 View:

- Display Waypoints as they are marked on the view. Waypoints can be marked at the boat position or cursor position.
- In a 360/Chart Combo View, you can see where your boat is positioned in relation to a waypoint on the Chart View and in relation to underwater structure in the 360 View [see **MEGA 360 Imaging Views** for more information].

Turn On/Off Navigation in the MEGA 360 Views [HELIX only]

Turn on the **Navigation on 360** menu option to mark and display waypoints on the 360 View. To hide waypoints on the 360 View, select off. If Navigation on 360 is turned off, you can mark waypoints, but they won't be displayed on the 360 View.

 **NOTE:** The GPS Receiver/Heading Sensor must be connected to the control head to enable these features on the 360 View.

1. **Main Menu:** Press the MENU key twice.
2. Select the Accessories tab > 360 Sonar Settings > Navigation on 360.
3. Press the RIGHT or LEFT Cursor keys to select On or Off.

Turn on **Navigation on 360** in the 360/Chart Combo View, and you can see where your boat is positioned in relation to underwater structure.

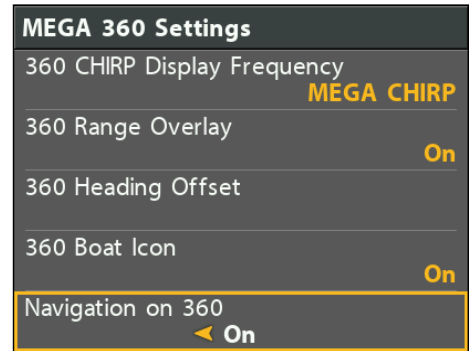

Mark a Waypoint

You can mark a waypoint at the boat position or the cursor position.

Mark a Waypoint at the Boat Position

SOLIX Series

1. Tap Sonar [360] in the status bar.
2. Select Mark.
3. Select Waypoint.

OR

1. Press the Mark key twice.

HELIX Series

1. Press the MARK key.

Mark a Waypoint at the Cursor Position

SOLIX Series

1. Press and hold a position on the 360 View.
2. Select Waypoint.

OR

1. Use the Joystick to move the cursor to a position on the 360 View.
2. Press the MARK key twice.

HELIX Series

1. Use the Cursor Control key to move the cursor to a position on the 360 View.
2. Press the MARK key twice.

Marking a Waypoint - Cursor Position (SOLIX)



Marking a Waypoint - Cursor Position (HELIX)



Power Off

1. Power Off the Control Head

Press and hold the POWER key.



WARNING! Turning off the control head will NOT power off the MEGA 360 Imaging transducer.

2. Power Off the Transducer

Turn off power on the main switch, breaker, or battery switch.



NOTE: Powering off the MEGA 360 Imaging transducer will be determined by the installation and power connection on your boat.

3. Check the MEGA 360 Trolling Motor Bracket

Confirm the Depth Collar Knob is fully tightened [by hand]. Check the stability of the trolling motor bracket after initial use and periodically thereafter to ensure that the installation and lock remain stable. See your installation guide for details.

CONTACT HUMMINBIRD

Contact Humminbird Technical Support in any of the following ways:

Web site:

humminbird.com

E-mail:

service@humminbird.com

Telephone:

1-800-633-1468

Direct Shipping:

Humminbird
Service Department
678 Humminbird Lane
Eufaula, AL 36027 USA

Hours of Operation:

Monday - Friday

8:00 a.m. to 4:30 p.m. [Central Standard Time]

Social Media Resources:



[Facebook.com/HumminbirdElectronics](https://www.facebook.com/HumminbirdElectronics)



[Twitter.com \[@humminbirdfish\]](https://twitter.com/@humminbirdfish)



[Instagram.com/humminbirdfishing](https://www.instagram.com/humminbirdfishing)



[YouTube.com/humminbirdtv](https://www.youtube.com/humminbirdtv)

